

Features

- Zero Reverse Recovery Current
- Merged PiN Schottky (MPS) Diodes Technologies
- Positive Temperature Coefficient
- High-Speed Switching
- Epoxy Meets UL 94 V-0 Flammability Rating
- Halogen Free. "Green" Device (Note 1)
- Lead Free Finish/RoHS Compliant(Note 2) ("P" Suffix designates RoHS Compliant. See ordering information)

Benefits

- Temperature-Independent Performance
- Low Switching Loss
- Low Heat Dissipation Requirements

Applications

- Switching Power Supply
- Power Factor Correction
- Motor Drive, Traction
- Charging Pile

Maximum Ratings

Parameter	Symbol	Rating	Unit
Peak Repetitive Reverse Voltage@ T _j =25°C	V _{RRM}	1200	V
Surge Peak Reverse Voltage@ T _j =25°C	V _{RSM}	1200	V
DC Reverse Voltage@ T _j =25°C	V _{DC}	1200	V
Continuous forward Current	@T _C =25°C	76	A
	@T _C =135°C	35	
	@T _C =144°C	30	
Non-repetitive Peak Forward Surge Current @T _C =25°C, t _p =10ms, Half Sine Pulse	I _{FSM}	320	A
Power Dissipation	@T _C =25°C	277	W
	@T _C =110°C	120	
i ² t Value@ T _C =25°C ,tp=10ms	∫i ² dt	512	A ² S

Note:1. Halogen free "Green" products are defined as those which contain <900ppm bromine, <900ppm chlorine (<1500ppm total Br + Cl) and <1000ppm antimony compounds.
2. High Temperature Solder Exemptions Applied, see EU Directive Annex 7a.

Internal Structure:

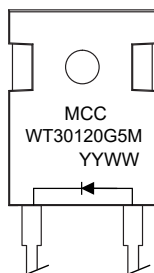
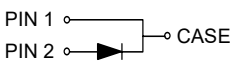

Device Code:WT30120G5M
YYWW: Date Code (Year & Week)

**30 Amp
Silicon Carbide
Schottky Diode
1200 Volts**

TO-247AD

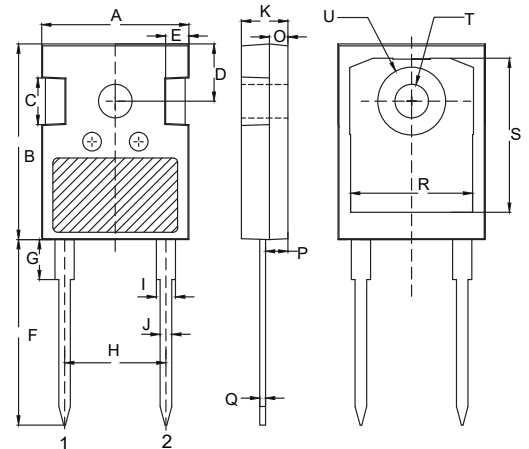

DIM	DIMENSIONS				NOTE
	INCHES		MM		
	MIN	MAX	MIN	MAX	
A	0.610	0.663	15.50	16.85	
B	0.815	0.839	20.70	21.30	
C	0.189	0.205	4.80	5.20	
D	0.242		6.15		BSC.
E	0.091	0.106	2.30	2.70	
F	0.772	0.796	19.62	20.22	
G	----	0.169	----	4.30	
H	0.428		10.88		BSC.
I	0.075	0.087	1.91	2.21	
J	0.044	0.054	1.11	1.36	
K	0.189	0.205	4.80	5.20	
O	0.073	0.085	1.85	2.15	
P	0.087	0.103	2.21	2.61	
Q	0.020	0.030	0.51	0.75	
R	0.512	0.535	13.00	13.60	
S	0.640	0.663	16.25	16.85	
T	0.134	0.150	3.40	3.80	Φ
U	----	0.287	----	7.30	Φ

Electrical Characteristics @ 25°C (Unless Otherwise Specified)

Parameter	Symbol	Conditions	Typ.	Max.	Units
Forward Voltage	V_F	$I_F=30A, T_J=25^{\circ}C$	1.35	1.60	V
		$I_F=30A, T_J=175^{\circ}C$	1.90		V
Reverse Leakage Current	I_R	$V_R=1200V, T_J=25^{\circ}C$	1.0	25	μA
		$V_R=1200V, T_J=175^{\circ}C$	50		μA
Total Capacitive Charge	Q_C	$V_R=800V$	180		nC
Total capacitance	C	$V_R=0V, f=1MHz$	2460		pF
		$V_R=400V, f=1MHz$	169		pF
		$V_R=800V, f=1MHz$	128		pF
Capacitance Stored Energy	E_C	$V_R=800V$	51		μJ

Thermal characteristics

Parameter	Symbol	Min	Typ	Max	Units
Operating Junction Temperature Range	T_J	-55		175	$^{\circ}C$
Storage Temperature Range	T_{stg}	-55		175	$^{\circ}C$
Thermal Resistance from Junction to Case	R_{thJ-C}		0.54		$^{\circ}C/W$

Curve Characteristics

Figure 1. Forward Characteristics

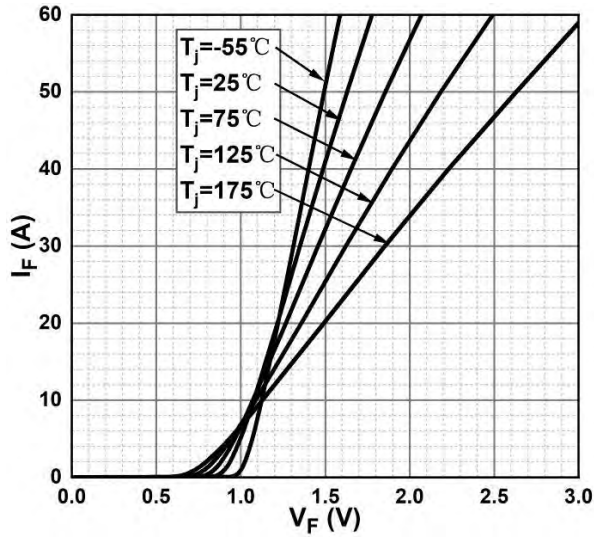

Figure 2. Reverse Characteristics

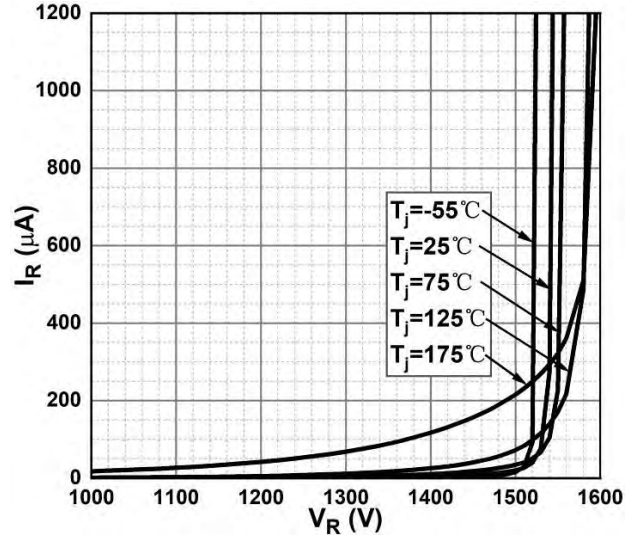

Figure 3. Capacitance vs. Reverse Voltage

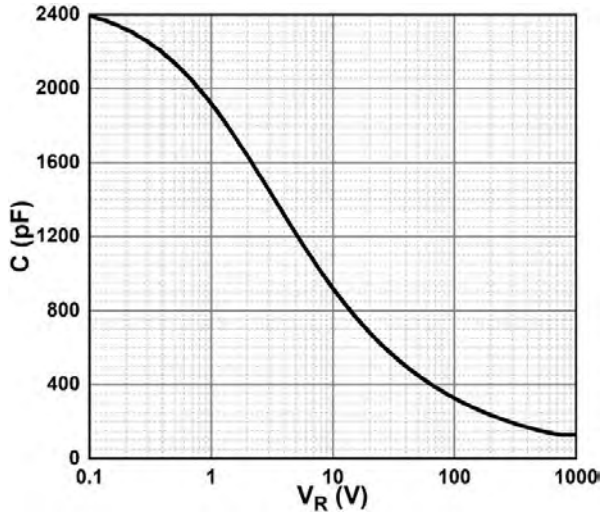

Figure 4. Total Capacitance Charge vs. Reverse Voltage

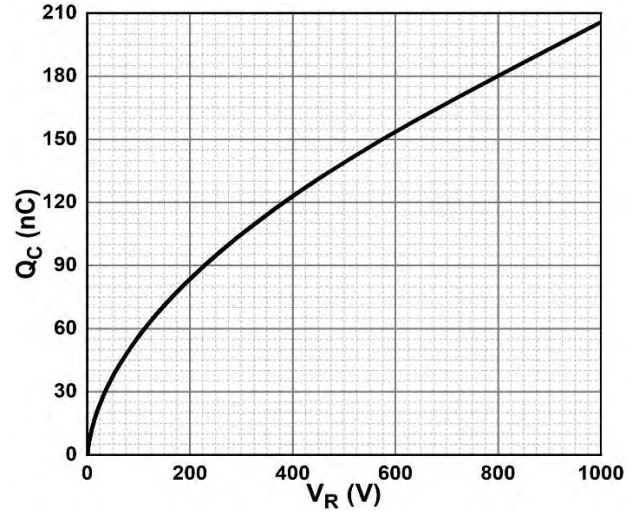

Figure 5. Capacitance Stored Energy

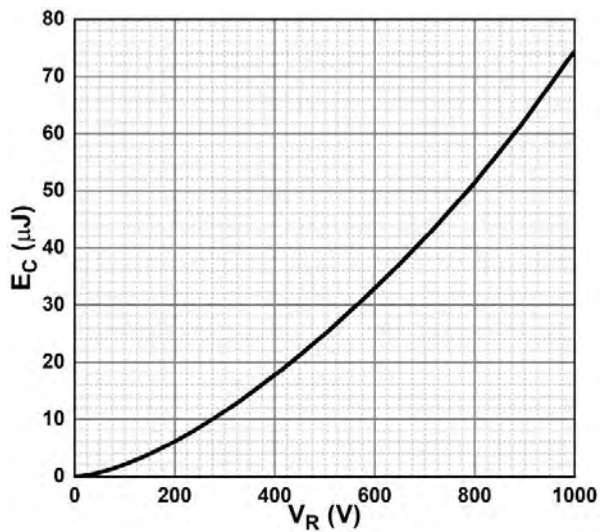
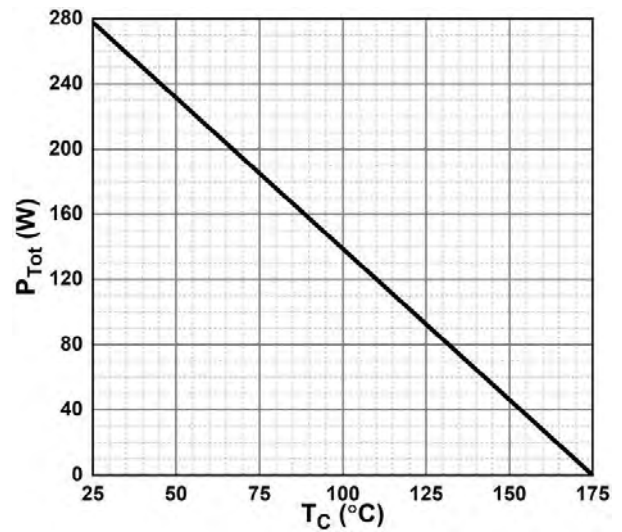

Figure 6. Power Derating



Curve Characteristics

Fig. 7 - Current Derating

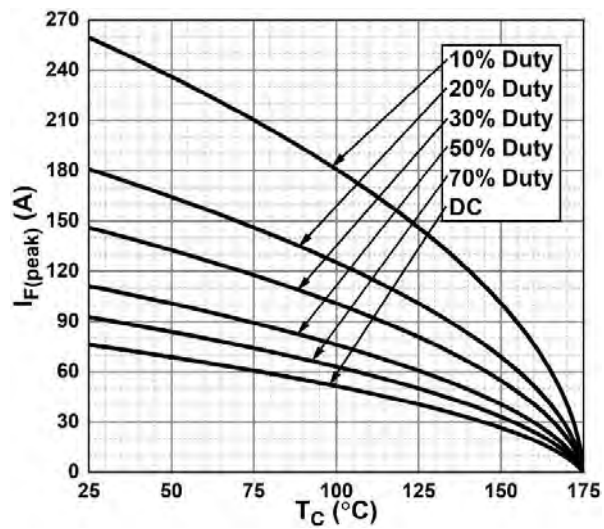
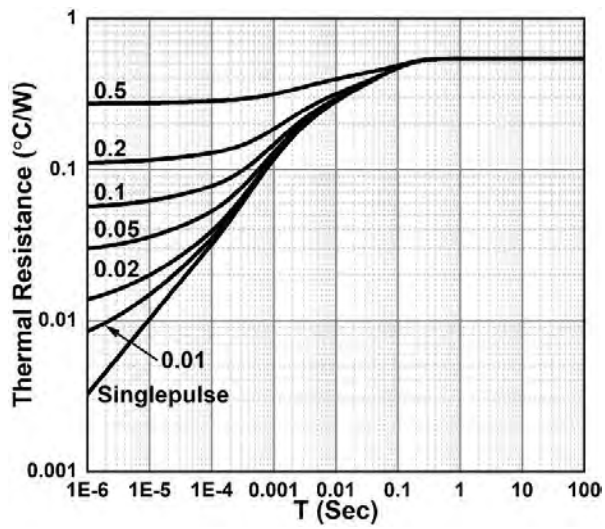

Fig. 8 - Transient Thermal Impedance



Ordering Information

Device	Packing
Part Number-BP	Bulk: 30pcs/Tube

IMPORTANT NOTICE

Micro Commercial Components Corp. reserves the right to make changes without further notice to any product herein to make corrections, modifications, enhancements, improvements, or other changes. **Micro Commercial Components Corp.** does not assume any liability arising out of the application or use of any product described herein; neither does it convey any license under its patent rights, nor the rights of others. The user of products in such applications shall assume all risks of such use and will agree to hold **Micro Commercial Components Corp.** and all the companies whose products are represented on our website, harmless against all damages. **Micro Commercial Components Corp.** products are sold subject to the general terms and conditions of commercial sale, as published at <https://www.mccsemi.com/Home/TermsAndConditions>.

LIFE SUPPORT

MCC's products are not authorized for use as critical components in life support devices or systems without the express written approval of Micro Commercial Components Corporation.

CUSTOMER AWARENESS

Counterfeiting of semiconductor parts is a growing problem in the industry. Micro Commercial Components (MCC) is taking strong measures to protect ourselves and our customers from the proliferation of counterfeit parts. MCC strongly encourages customers to purchase MCC parts either directly from MCC or from Authorized MCC Distributors who are listed by country on our web page cited below. Products customers buy either from MCC directly or from Authorized MCC Distributors are genuine parts, have full traceability, meet MCC's quality standards for handling and storage. **MCC will not provide any warranty coverage or other assistance for parts bought from Unauthorized Sources.** MCC is committed to combat this global problem and encourage our customers to do their part in stopping this practice by buying direct or from authorized distributors.