

**Features**

- Split Gate Trench MOSFET Technology
- High Density Cell Design for Ultra Low RDS(on)
- Moisture Sensitivity Level 1
- Halogen Free."Green"Device<sup>(Note1)</sup>
- Epoxy Meets UL 94 V-0 Flammability Rating
- Lead Free Finish/RoHS Compliant<sup>(Note2)</sup> ("P" Suffix Designates RoHS Compliant. See Ordering Information)

**Maximum Ratings**

- Operating Junction Temperature Range: -55°C to +175°C
- Storage Temperature Range: -55°C to +175°C
- Thermal Resistance: 60°C/W Junction to Ambient<sup>(Note3)</sup>
- Thermal Resistance: 1.2°C/W Junction to Case

Parameter	Symbol	Rating	Unit
Drain-Source Voltage	V <sub>DS</sub>	40	V
Gate-Source Voltage	V <sub>GS</sub>	±20	V
Continuous Drain Current	I <sub>D</sub>	T <sub>C</sub> =25°C	180
		T <sub>C</sub> =100°C	127
Pulsed Drain Current <sup>(Note4)</sup>	I <sub>DM</sub>	720	A
Total Power Dissipation <sup>(Note5)</sup>	P <sub>D</sub>	125	W
Single Pulsed Avalanche Energy <sup>(Note6)</sup>	E <sub>AS</sub>	506	mJ

Note:

1. Halogen free "Green" products are defined as those which contain <900ppm bromine, <900ppm chlorine (<1500ppm total Br + Cl) and <1000ppm antimony compounds.

2. High Temperature Solder Exemption Applied, see EU Directive Annex 7(a)-l.

3. The value of R<sub>θJA</sub> is measured with the device mounted on 1in<sup>2</sup> FR-4 board with 2oz. Copper, in a still air environment with T<sub>A</sub>=25°C.

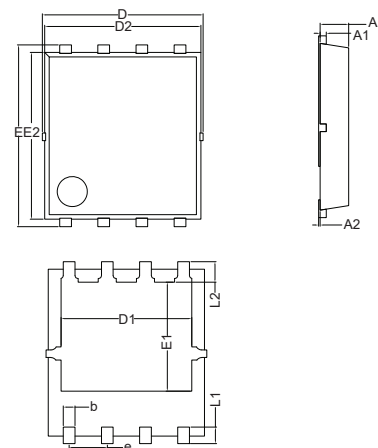
4. Repetitive rating; pulse width limited by max. junction temperature.

5. P<sub>D</sub> is based on max. junction temperature, using junction-case thermal resistance.

6. E<sub>AS</sub> is based on max. junction temperature, using junction-case thermal resistance.

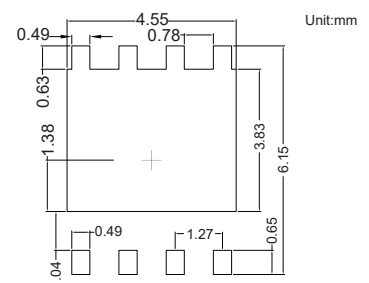
**N-Channel MOSFET**

**DFN5060-C**

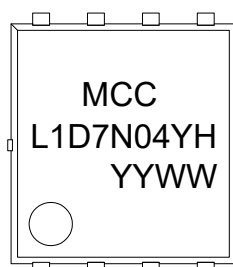
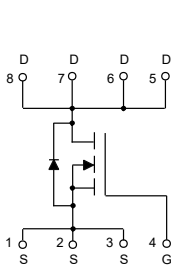


DIM	DIMENSIONS				NOTE
	INCHES		MM		
D	0.203	0.218	5.15	5.55	
D2	0.201	0.209	5.10	5.30	
E	0.234	0.242	5.95	6.15	
E2	0.215	0.222	5.45	5.65	
A	0.033	0.041	0.85	1.05	
A1	0.008		0.203		BSC
A2	0.000	0.004	0.00	0.10	
D1	0.167	0.175	4.25	4.45	
E1	0.139	0.147	3.52	3.73	
L1	0.018	0.026	0.45	0.65	
L2	0.027		0.68		BSC
b	0.012	0.020	0.30	0.50	
e	0.050		1.27		BSC

**Suggested Solder Pad Layout**



**Internal Structure and Marking Code**



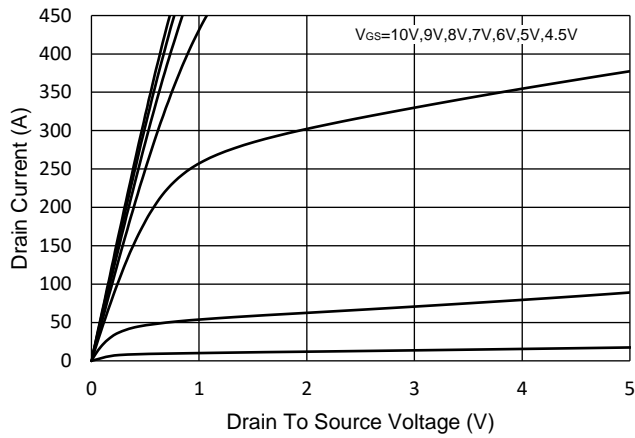
4 codes in total  
YY is the year  
WW is the week

**Electrical Characteristics @ 25°C (Unless Otherwise Specified)**

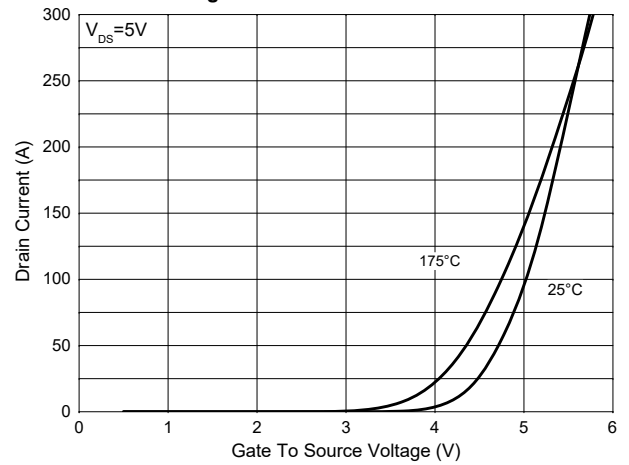
Parameter	Symbol	Test Conditions	Min	Typ	Max	Unit
<b>Static Characteristics</b>						
Drain-Source Breakdown Voltage	$V_{(BR)DSS}$	$V_{GS}=0V, I_D=250\mu A$	40			V
Gate-Source Leakage Current	$I_{GSS}$	$V_{DS}=0V, V_{GS}=\pm 20V$			$\pm 100$	nA
Zero Gate Voltage Drain Current	$I_{DSS}$	$V_{DS}=40V, V_{GS}=0V$			1	$\mu A$
Gate-Threshold Voltage	$V_{GS(th)}$	$V_{DS}=V_{GS}, I_D=250\mu A$	2	3	4	V
Drain-Source On-Resistance	$R_{DS(on)}$	$V_{GS}=10V, I_D=20A$		1.3	1.7	m $\Omega$
Gate Resistance	$R_g$	f=1 MHz, Open Drain		1.5		$\Omega$
<b>Diode Characteristics</b>						
Continuous Body Diode Current	$I_S$				180	A
Diode Forward Voltage	$V_{SD}$	$V_{GS}=0V, I_S=20A$			1.2	V
Reverse Recovery Time	$t_{rr}$	$I_F=40A, dI/dt=100A/\mu s$		60		ns
Reverse Recovery Charge	$Q_{rr}$			53		nC
<b>Dynamic Characteristics</b>						
Input Capacitance	$C_{iss}$	$V_{DS}=20V, V_{GS}=0V, f=1MHz$		4317		pF
Output Capacitance	$C_{oss}$			1510		
Reverse Transfer Capacitance	$C_{rss}$			28		
Total Gate Charge	$Q_g$	$V_{DS}=20V, V_{GS}=10V, I_D=90A$		57		nC
Gate-Source Charge	$Q_{gs}$			24		
Gate-Drain Charge	$Q_{gd}$			10		
Turn-On Delay Time	$t_{d(on)}$	$V_{DD}=20V, V_{GS}=10V,$ $R_G=3\Omega, I_D=90A$		19		ns
Turn-On Rise Time	$t_r$			25		
Turn-Off Delay Time	$t_{d(off)}$			32		
Turn-Off Fall Time	$t_f$			53		

## Curve Characteristics

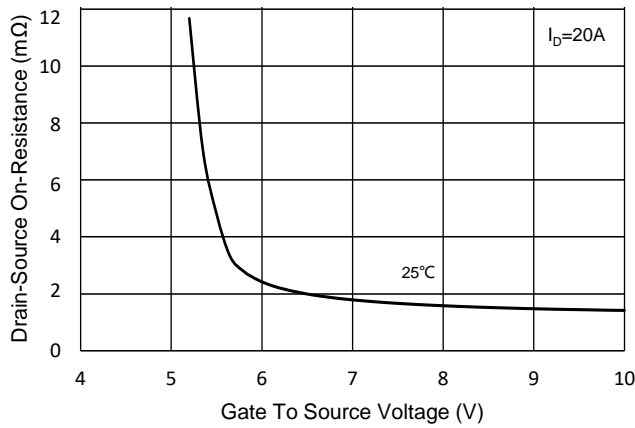
**Fig.1 - Typical Output Characteristics**



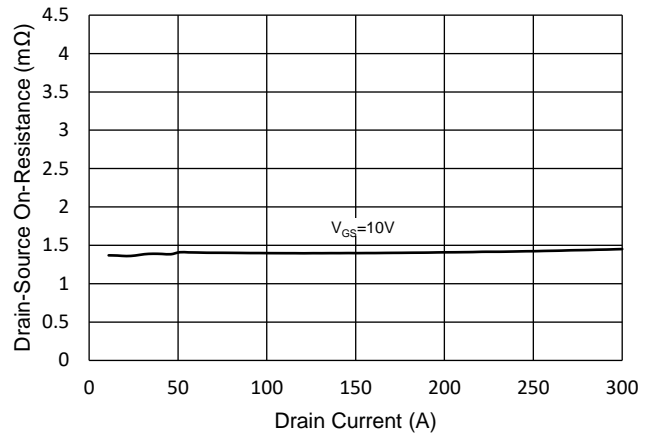
**Fig. 2 - Transfer Characteristics**



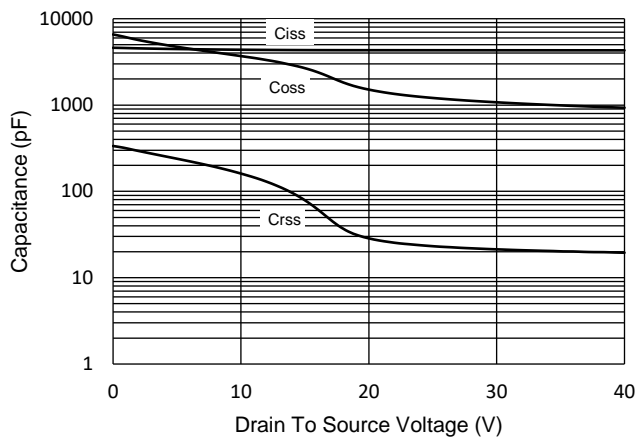
**Fig.3 -  $R_{DS(ON)}$  -  $V_{GS}$**



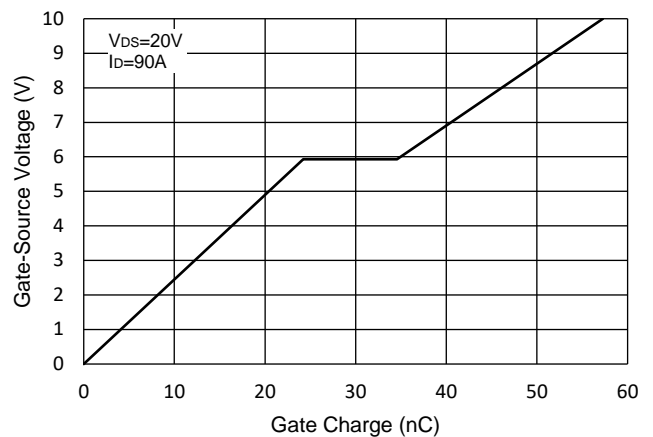
**Fig.4 -  $R_{DS(ON)}$  -  $I_D$**



**Fig.5 - Capacitance Characteristics**

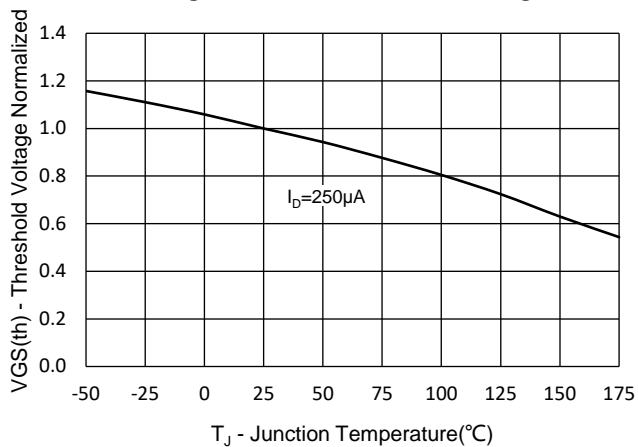


**Fig.6 - Gate Charge**

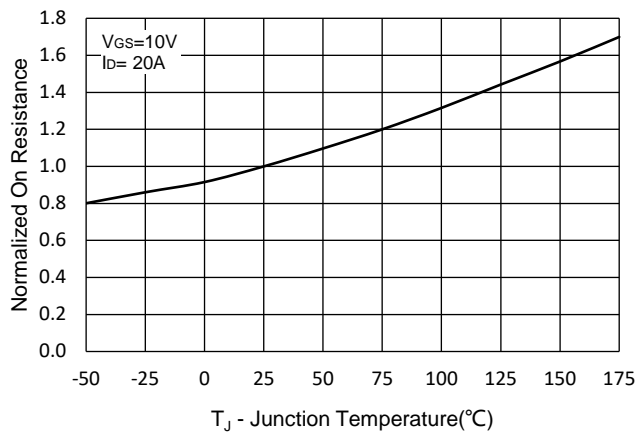


**Curve Characteristics**

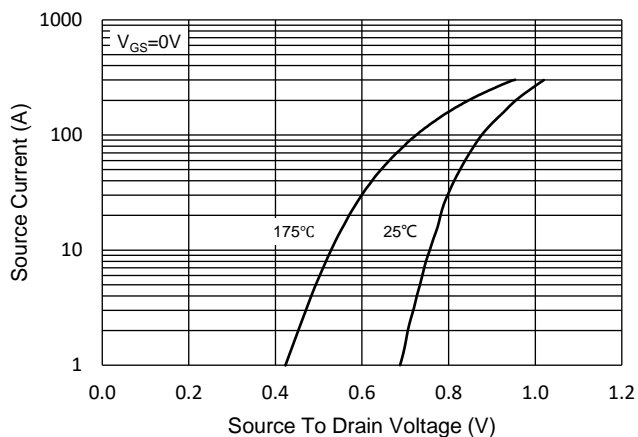
**Fig.7 - Normalized Threshold Voltage**



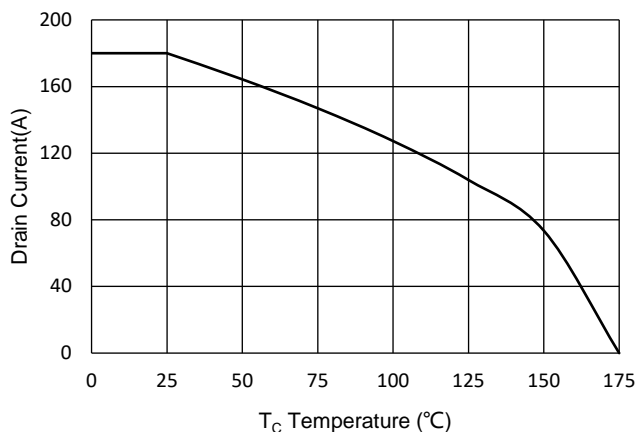
**Fig.8 - Normalized On Resistance Characteristics**



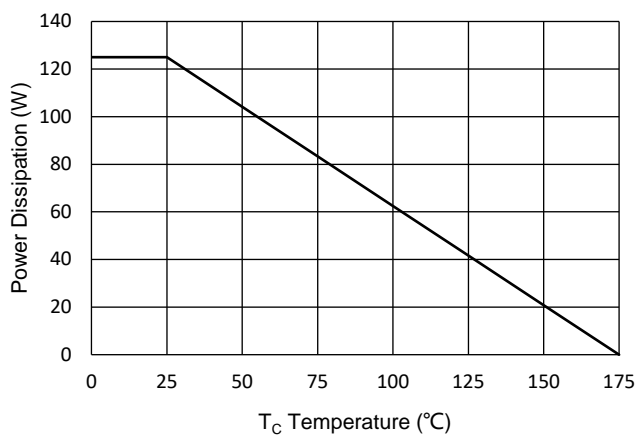
**Fig.9 - I<sub>S</sub> - V<sub>SD</sub>**



**Fig.10 - Drain Current**



**Fig.11 - PD Dissipation**



Curve Characteristics

Fig. 12 - Safe Operation Area

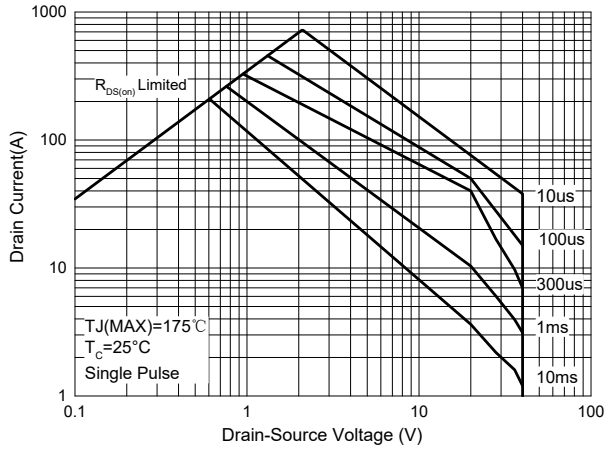
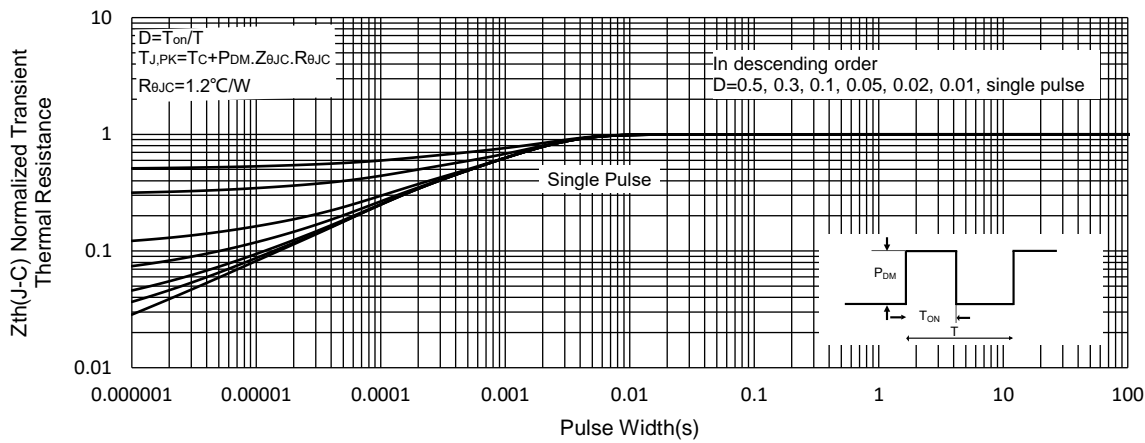


Fig.13 - Normalized Transient Thermal Impedance



## Ordering Information

Device	Packing
Part Number-TP	Tape&Reel: 5Kpcs/Reel

**\*\*\*IMPORTANT NOTICE\*\*\***

**Micro Commercial Components Corp.** reserves the right to make changes without further notice to any product herein to make corrections, modifications , enhancements , improvements , or other changes . **Micro Commercial Components Corp.** does not assume any liability arising out of the application or use of any product described herein; neither does it convey any license under its patent rights ,nor the rights of others . The user of products in such applications shall assume all risks of such use and will agree to hold **Micro Commercial Components Corp.** and all the companies whose products are represented on our website, harmless against all damages. **Micro Commercial Components Corp.** products are sold subject to the general terms and conditions of commercial sale, as published at <https://www.mccsemi.com/Home/TermsAndConditions>.

**\*\*\*LIFE SUPPORT\*\*\***

MCC's products are not authorized for use as critical components in life support devices or systems without the express written approval of Micro Commercial Components Corporation.

**\*\*\*CUSTOMER AWARENESS\*\*\***

Counterfeiting of semiconductor parts is a growing problem in the industry. Micro Commercial Components (MCC) is taking strong measures to protect ourselves and our customers from the proliferation of counterfeit parts. MCC strongly encourages customers to purchase MCC parts either directly from MCC or from Authorized MCC Distributors who are listed by country on our web page cited below. Products customers buy either from MCC directly or from Authorized MCC Distributors are genuine parts, have full traceability, meet MCC's quality standards for handling and storage. **MCC will not provide any warranty coverage or other assistance for parts bought from Unauthorized Sources.** MCC is committed to combat this global problem and encourage our customers to do their part in stopping this practice by buying direct or from authorized distributors.