

Features

- Halogen Free. "Green" Device (Note 1)
- AEC-Q101 Qualified
- Glass Passivated Junction
- Ultra Fast Switching For High Efficiency
- For Surface Mounted Applications
- Epoxy Meets UL 94 V-0 Flammability Rating
- Moisture Sensitivity Level 1
- Lead Free Finish/RoHS Compliant (Note 2)("P" Suffix Designates RoHS Compliant. See Ordering Information)

Maximum Ratings @ 25°C (Unless Otherwise Specified)

Parameter	Symbol	Value	Unit
Peak Repetitive Reverse Voltage	V_{RRM}	200	V
Working Peak Reverse Voltage	V_{RWM}		
DC Blocking Voltage	V_R		
RMS Reverse Voltage	V_{RMS}	140	V
Average Rectified Forward Current @ $T_L=105^\circ\text{C}$	$I_{F(AV)}$	2	A
Non-Repetitive Peak Surge Current @ 8.3ms Half Sine Wave	I_{FSM}	50	A
Current Squared Time @ $1\text{ms} \leq t \leq 8.3\text{ms}$	I^2t	10.375	A^2s

Internal Structure

Pin	Description	Simplified outline	Graphic symbol
1	cathode		
2	anode		

Note: 1. Halogen free "Green" products are defined as those which contain <900ppm bromine, <900ppm chlorine (<1500ppm total Br + Cl) and <1000ppm antimony compounds.

2. High Temperature Solder Exemption Applied, see EU Directive Annex 7a.

2 Amp Surface Mount Ultra Fast Recovery Rectifier 200 Volts

SMA (DO-214AC)

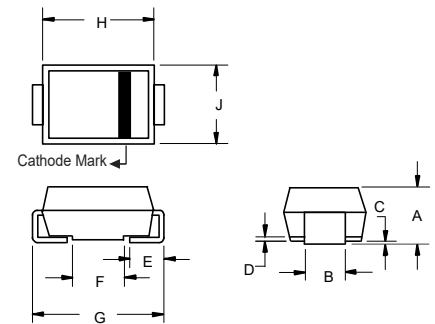

DIM	INCHES		MM		NOTE
	MIN	MAX	MIN	MAX	
A	0.075	0.096	1.90	2.44	
B	0.050	0.064	1.27	1.63	
C	0.002	0.008	0.051	0.203	
D	---	0.020	---	0.51	
E	0.030	0.060	0.76	1.52	
F	0.065	0.091	1.65	2.32	
G	0.189	0.220	4.80	5.59	
H	0.157	0.187	4.00	4.75	
J	0.090	0.115	2.25	2.92	

SUGGESTED SOLDER PAD LAYOUT

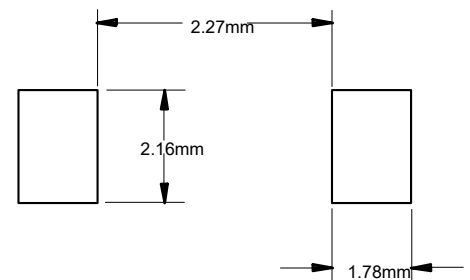

Thermal characteristics

Symbol	Parameter	Conditions	Min	Typ	Max	Unit
T_J	Operating Junction Temperature Range		-55		150	°C
T_{stg}	Storage Temperature Range		-55		150	°C
$R_{th(J-L)}$	Thermal Resistance from Junction to Lead	Note 1		25		°C/W
$R_{th(J-A)}$	Thermal Resistance from Junction to Ambient	Note 1		70		°C/W

Note:

1. Mounted on P.C.B. with 5mm*5mm copper pad areas.

Electrical Characteristics @ 25°C Unless Otherwise Specified

Parameter	Symbol	Test Conditions	Min	Typ	Max	Unit
Forward Voltage	V_F	$I_F=2A; T_J=25^\circ C$		0.87	0.92	V
Reverse Current	I_R	at Rated $V_R; T_J=25^\circ C$ at Rated $V_R; T_J=125^\circ C$			2 20	uA
Junction Capacitance	C_J	$V_R=4V; f=1MHz; T_J=25^\circ C$		25		pF

Dynamic Recovery Characteristics @ 25°C Unless Otherwise Specified

Parameter	Symbol	Test Conditions	Min	Typ	Max	Unit
Reverse Recovery Time	t_{rr}	$I_F=0.5A; I_R=1.0A; I_{RR}=0.25A; T_J=25^\circ C$			25	ns
		$I_F=1A, di/dt=-50A/us, V_R=30V; T_J=25^\circ C$		26		
		$T_J=25^\circ C$		25		
		$T_J=125^\circ C$		30		
Peak Recovery Current	I_{RRM}	$I_F=2A$ $di/dt=-200A/\mu s$ $V_R=100V$	$T_J=25^\circ C$		3.5	A
			$T_J=125^\circ C$		6.0	
Reverse Recovery Charge	Q_{rr}		$T_J=25^\circ C$		47	nC
			$T_J=125^\circ C$		85	

Curve Characteristics

Fig. 1 - Forward Current Derating Curve

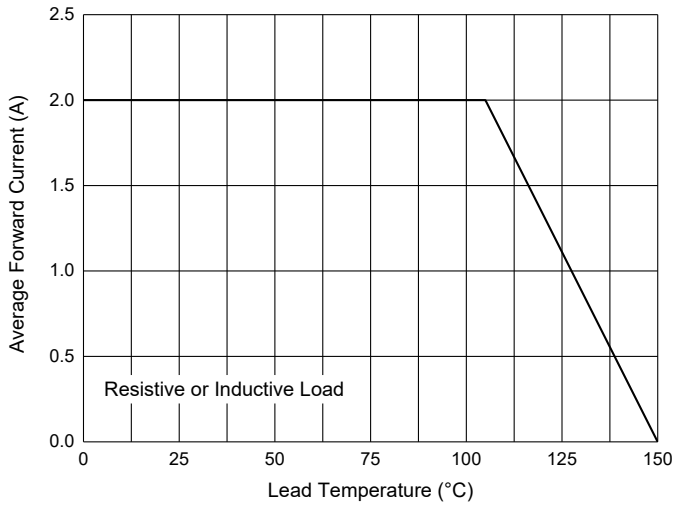

Fig. 2 - Maximum Non-Repetitive Peak Forward Surge Current

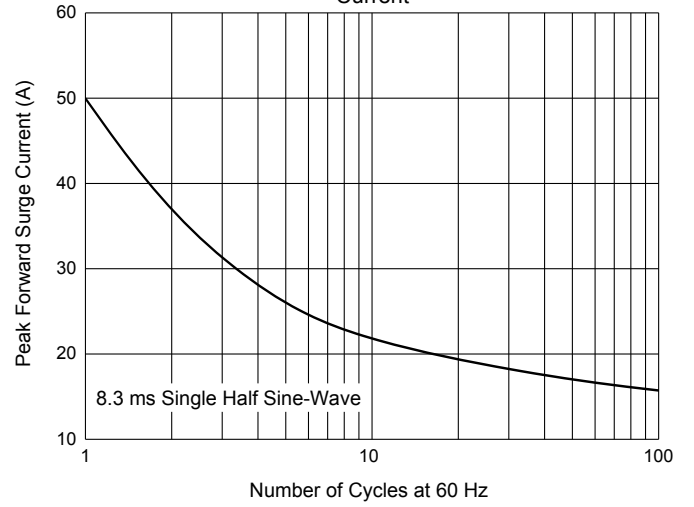

Fig. 3 - Typical Instantaneous Forward Characteristics

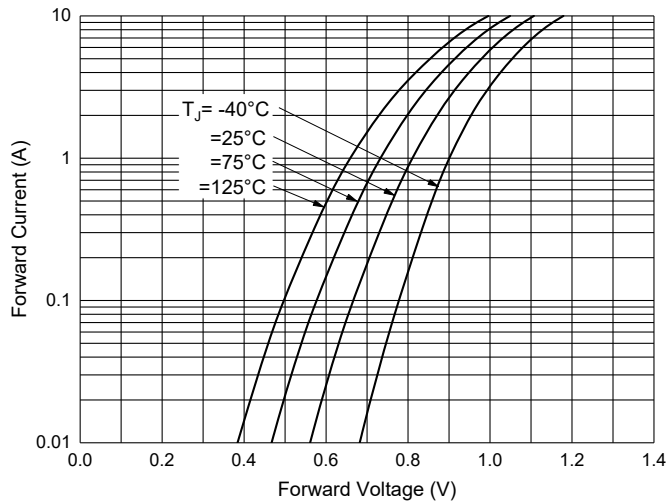

Fig. 4 - Typical Reverse Leakage Characteristics

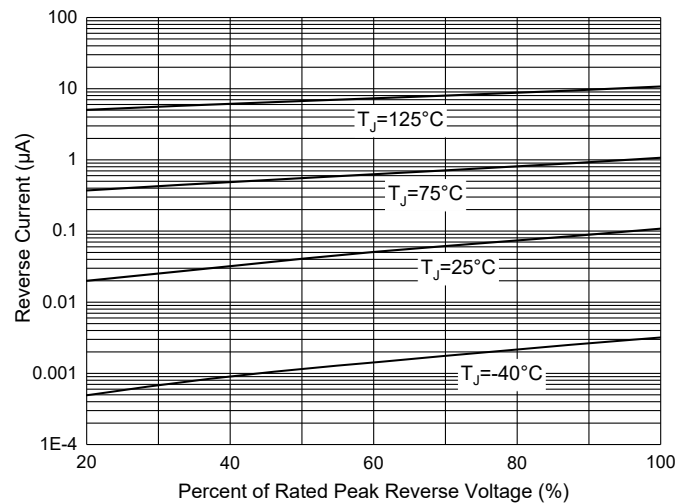
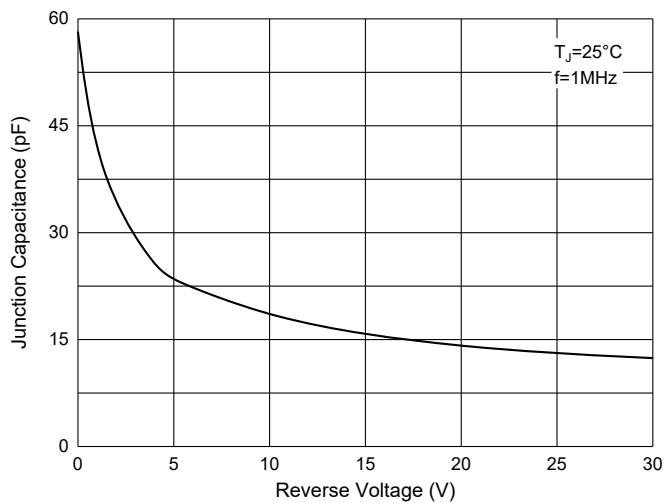

Fig. 5 - Typical Capacitance Characteristics



Ordering Information

Device	Packing
Part Number-TP	Tape&Reel:5Kpcs/Reel

IMPORTANT NOTICE

Micro Commercial Components Corp. reserves the right to make changes without further notice to any product herein to make corrections, modifications , enhancements , improvements , or other changes . *Micro Commercial Components Corp.* does not assume any liability arising out of the application or use of any product described herein; neither does it convey any license under its patent rights ,nor the rights of others . The user of products in such applications shall assume all risks of such use and will agree to hold *Micro Commercial Components Corp.* and all the companies whose products are represented on our website, harmless against all damages. *Micro Commercial Components Corp.* products are sold subject to the general terms and conditions of commercial sale, as published at <https://www.mccsemi.com/Home/TermsAndConditions>.

LIFE SUPPORT

MCC's products are not authorized for use as critical components in life support devices or systems without the express written approval of Micro Commercial Components Corporation.

CUSTOMER AWARENESS

Counterfeiting of semiconductor parts is a growing problem in the industry. Micro Commercial Components (MCC) is taking strong measures to protect ourselves and our customers from the proliferation of counterfeit parts. MCC strongly encourages customers to purchase MCC parts either directly from MCC or from Authorized MCC Distributors who are listed by country on our web page cited below. Products customers buy either from MCC directly or from Authorized MCC Distributors are genuine parts, have full traceability, meet MCC's quality standards for handling and storage. **MCC will not provide any warranty coverage or other assistance for parts bought from Unauthorized Sources.** MCC is committed to combat this global problem and encourage our customers to do their part in stopping this practice by buying direct or from authorized distributors.