

**Features**

- Glass Passivated Junction
- Lead Free Finish/RoHS Compliant (Note 1)("P" Suffix Designates RoHS Compliant. See Ordering Information)
- Epoxy Meets UL 94 V-0 Flammability Rating
- Halogen Free. "Green" Device (Note 2)
- Moisture Sensitivity Level 1

**Maximum Ratings @ 25°C (Unless Otherwise Specified)**

Parameter	Symbol	Value	Unit
Peak Repetitive Reverse Voltage	$V_{RRM}$	600	V
Working Peak Reverse Voltage	$V_{RWM}$		
DC Blocking Voltage	$V_R$		
RMS Reverse Voltage	$V_{RMS}$	420	V
Average Rectified Forward Current @ $T_L=85^\circ\text{C}$	$I_{F(AV)}$	3	A
Non-Repetitive Peak Surge Current @8.3ms Half Sine Wave	$I_{FSM}$	100	A
Non-Repetitive Peak Surge Current @1ms Square Wave		200	
Current Squared Time @ $1\text{ms} \leq t \leq 8.3\text{ms}$	$I^2t$	41.5	$\text{A}^2\text{s}$

**3 Amp  
Super Fast  
Recovery Rectifier  
600 Volts**

**SMB (DO-214AA)**

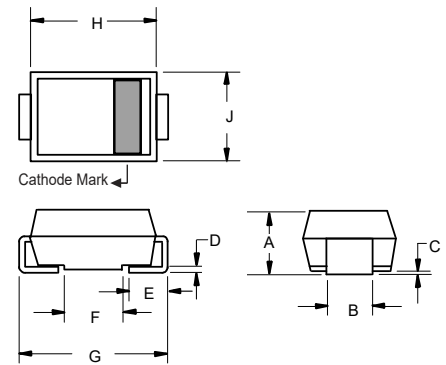

DIM	INCHES		MM		NOTE
	MIN	MAX	MIN	MAX	
A	0.079	0.103	2.00	2.62	
B	0.075	0.087	1.91	2.21	
C	0.002	0.008	0.05	0.20	
D	0.006	0.012	0.15	0.31	
E	0.030	0.060	0.76	1.52	
F	0.065	0.091	1.65	2.32	
G	0.200	0.220	5.08	5.59	
H	0.160	0.191	4.06	4.85	
J	0.130	0.155	3.30	3.94	

**Internal Structure**

Pin	Description	Simplified Outline	Graphic Symbol
1	Cathode		
2	Anode		

Note:

1. High temperature solder exemption applied, see EU directive annex 7a.
2. Halogen free "Green" products are defined as those which contain <900ppm bromine, <900ppm chlorine (<1500ppm total Br + Cl) and <1000ppm antimony compounds.

**Suggested Solder Pad Layout**

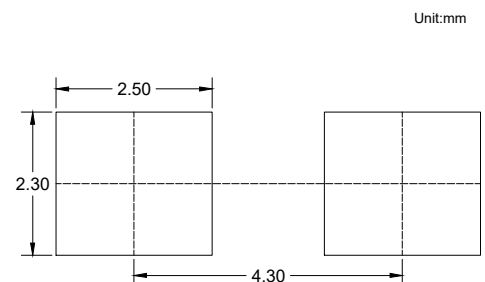

### Thermal characteristics

Symbol	Parameter	Conditions	Min	Typ	Max	Unit
$T_J$	Operating Junction Temperature Range		-55		150	°C
$T_{stg}$	Storage Temperature Range		-55		150	°C
$R_{th(J-L)}$	Thermal Resistance from Junction to Lead	Note 1		20		°C/W
$R_{th(J-A)}$	Thermal Resistance from Junction to Ambient	Note 1		75		°C/W

Note:

1. Mounted on P.C.B. with 8mm\*8mm copper pad areas.

### Electrical Characteristics @ 25°C Unless Otherwise Specified

Parameter	Symbol	Test Conditions	Min	Typ	Max	Unit
Forward Voltage	$V_F$	$I_F=3A; T_J=25^\circ C$			1.25	V
Reverse Current	$I_R$	at Rated $V_R; T_J=25^\circ C$ at Rated $V_R; T_J=125^\circ C$			5 50	$\mu A$
Junction Capacitance	$C_J$	$V_R=4V; f=1MHz; T_J=25^\circ C$		50		pF

### Dynamic Recovery Characteristics @ 25°C Unless Otherwise Specified

Parameter	Symbol	Test Conditions	Min	Typ	Max	Unit
Reverse Recovery Time	$t_{rr}$	$I_F=0.5A; I_R=1.0A; I_{RR}=0.25A; T_J=25^\circ C$			50	ns
		$I_F=1A, di/dt=-50A/\mu s, V_R=30V; T_J=25^\circ C$		48		
		$T_J=25^\circ C$		47		
		$T_J=125^\circ C$		71		
Peak Recovery Current	$I_{RRM}$	$I_F=3A$ $di/dt=-200A/\mu s$ $V_R=400V$	$T_J=25^\circ C$		5.9	A
			$T_J=125^\circ C$		9.0	
Reverse Recovery Charge	$Q_{rr}$		$T_J=25^\circ C$		138	nC
			$T_J=125^\circ C$		319	

## Curve Characteristics

Fig. 1 - Forward Current Derating Curve

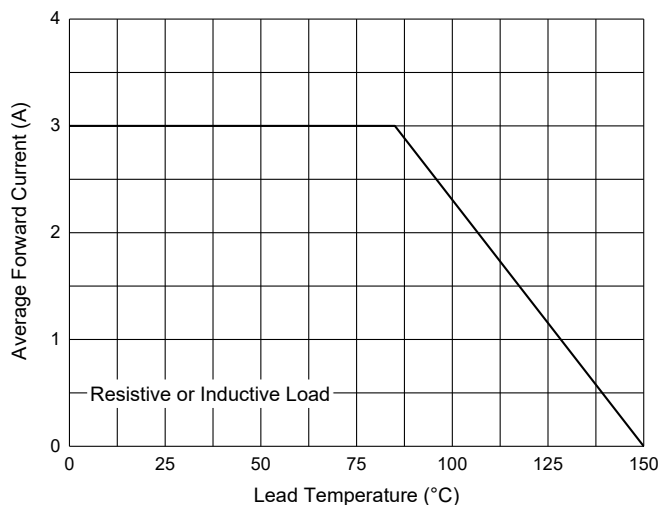

Fig. 2 - Maximum Non-Repetitive Peak Forward Surge Current

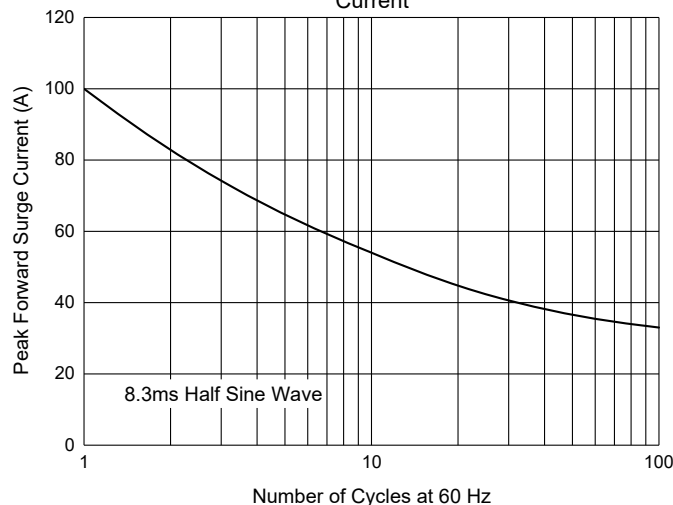

Fig. 3 - Typical Instantaneous Forward Characteristics

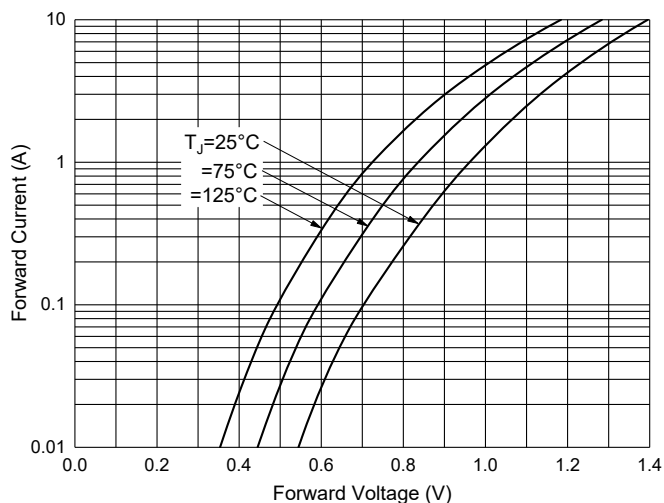

Fig. 4 - Typical Reverse Leakage Characteristics

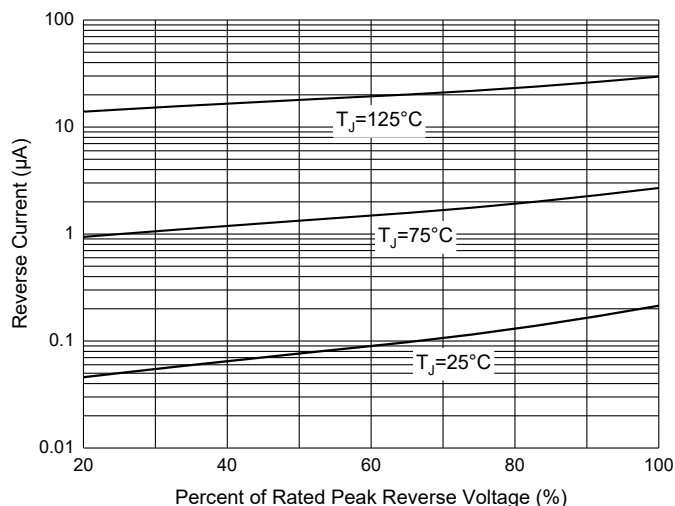
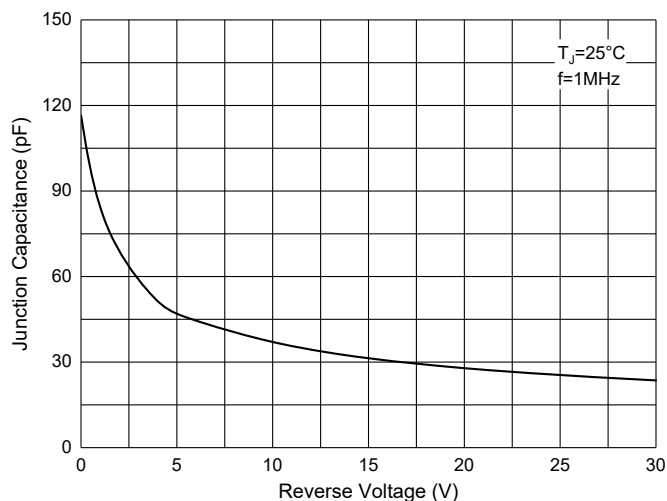

Fig. 5 - Typical Capacitance Characteristics



## Ordering Information

Device	Packing
MURS3JB-TP	Tape&Reel:3Kpcs/Reel

### \*\*\*IMPORTANT NOTICE\*\*\*

**Micro Commercial Components Corp.** reserves the right to make changes without further notice to any product herein to make corrections, modifications , enhancements , improvements , or other changes . **Micro Commercial Components Corp** . does not assume any liability arising out of the application or use of any product described herein; neither does it convey any license under its patent rights ,nor the rights of others . The user of products in such applications shall assume all risks of such use and will agree to hold **Micro Commercial Components Corp** . and all the companies whose products are represented on our website, harmless against all damages. **Micro Commercial Components Corp.** products are sold subject to the general terms and conditions of commercial sale, as published at <https://www.mccsemi.com/Home/TermsAndConditions>.

### \*\*\*LIFE SUPPORT\*\*\*

MCC's products are not authorized for use as critical components in life support devices or systems without the express written approval of Micro Commercial Components Corporation.

### \*\*\*CUSTOMER AWARENESS\*\*\*

Counterfeiting of semiconductor parts is a growing problem in the industry. Micro Commercial Components (MCC) is taking strong measures to protect ourselves and our customers from the proliferation of counterfeit parts. MCC strongly encourages customers to purchase MCC parts either directly from MCC or from Authorized MCC Distributors who are listed by country on our web page cited below. Products customers buy either from MCC directly or from Authorized MCC Distributors are genuine parts, have full traceability, meet MCC's quality standards for handling and storage. **MCC will not provide any warranty coverage or other assistance for parts bought from Unauthorized Sources.** MCC is committed to combat this global problem and encourage our customers to do their part in stopping this practice by buying direct or from authorized distributors.