



E502650

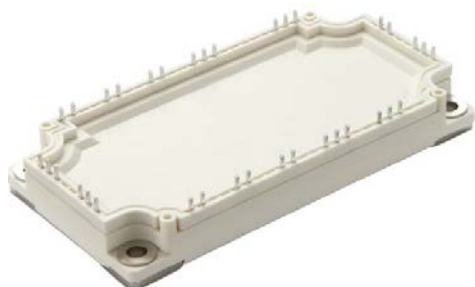
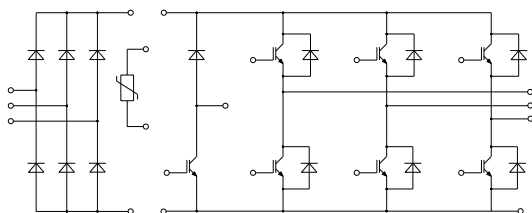
### Features

- Low Switching Losses
- Low  $V_{ce(sat)}$  with Positive Temperature Coefficient
- Including Fast & Soft Recovery Anti-parallel FWD
- Low Inductance Case
- High Short Circuit Capability(10 $\mu$ s)
- Maximum Junction Temperature 175°C
- Epoxy Meets UL 94 V-0 Flammability Rating
- Lead Free Finish/RoHS Compliant ("P" Suffix Designates RoHS Compliant. See Ordering Information)

### Applications

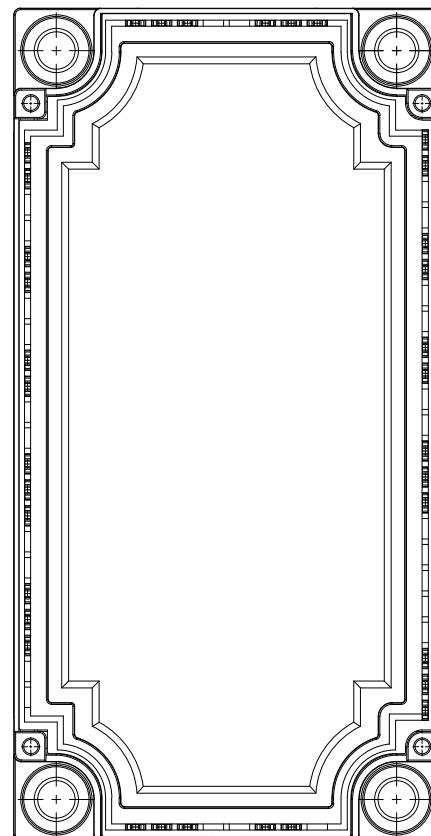
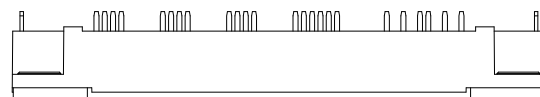
- Motor Drivers
- AC and DC Servo Drive Amplifier
- UPS (Uninterruptible Power Supplies)

### Circuit Diagram



## IGBT Modules 1200V 75A

E2



● IGBT- Inverter

Maximum Ratings

Parameter	Symbol	Test Conditions	Rating	Unit
Collector-Emitter Voltage	$V_{CES}$	$V_{GE}=0V, I_C=1mA, T_{vj}=25^{\circ}C$	1200	V
Continuous Collector Current	$I_C$	$T_C=80^{\circ}C, T_{vjmax}=175^{\circ}C$	75	A
Repetitive Peak Collector Current	$I_{CRM}$	$t_p=1ms$	150	A
Gate-Emitter Voltage	$V_{GES}$	$T_{vj}=25^{\circ}C$	$\pm 20$	V
Total Power Dissipation	$P_{tot}$	$T_C=25^{\circ}C, T_{vjmax}=175^{\circ}C$	470	W

Electrical Characteristics

Parameter	Symbol	Test Conditions	Min	Typ	Max	Unit
Gate-Emitter Threshold Voltage	$V_{GE(th)}$	$V_{GE}=V_{CE}, I_C=3.3mA, T_{vj}=25^{\circ}C$	5.0	5.8	6.6	V
Collector-Emitter Cut-off Current	$I_{CES}$	$V_{CE}=1200V, V_{GE}=0V, T_{vj}=25^{\circ}C$			1.0	mA
Collector-Emitter Saturation Voltage	$V_{CE(sat)}$	$I_C=75A, V_{GE}=15V, T_{vj}=25^{\circ}C$		1.95	2.40	V
		$I_C=75A, V_{GE}=15V, T_{vj}=125^{\circ}C$		2.20		V
		$I_C=75A, V_{GE}=15V, T_{vj}=150^{\circ}C$		2.30		V
Gate Charge	$Q_g$			0.85		$\mu C$
Input Capacitance	$C_{ies}$	$V_{CE}=25V, V_{GE}=0V, f=1MHz, T_{vj}=25^{\circ}C$		4.20		nF
Reverse Transfer Capacitance	$C_{res}$			0.32		
Gate-Emitter leakage current	$I_{GES}$	$V_{CE}=0V, V_{GE}=20V, T_{vj}=25^{\circ}C$			400	nA
Turn-On Delay Time	$t_{d(on)}$	$V_{CE}=600V, I_C=75A, V_{GE}=\pm 15V, R_G=2.2\Omega, T_{vj}=25^{\circ}C$		75		ns
Rise Time	$t_r$			40		
Turn-Off Delay Time	$t_{d(off)}$			163		
Fall Time	$t_f$			235		
Turn-On Energy	$E_{on}$			4.71		
Turn-Off Energy	$E_{off}$		5.45			
Turn-On Delay Time	$t_{d(on)}$	$V_{CE}=600V, I_C=75A, V_{GE}=\pm 15V, R_G=2.2\Omega, T_{vj}=150^{\circ}C$		77		ns
Rise Time	$t_r$			47		
Turn-Off Delay Time	$t_{d(off)}$			173		
Fall Time	$t_f$			309		
Turn-On Energy	$E_{on}$			6.73		
Turn-Off Energy	$E_{off}$		6.24			
SC Data	$I_{SC}$	$T_p \leq 10\mu s, V_{GE}=15V, T_{vj}=150^{\circ}C, V_{CC}=900V, V_{CEM} \leq 1200V$		300		A

## ● Diode- Inverter

### Maximum Ratings

Parameter	Symbol	Test Conditions	Rating	Unit
Repetitive Peak Reverse Voltage	$V_{RRM}$	$T_{vj}=25^{\circ}C$	1200	V
Continuous DC Forward Current	$I_F$		75	A
Repetitive Peak Forward Current	$I_{FRM}$	$t_p=1ms$	150	A
$I^2t$ -value	$I^2t$	$V_R=0, t_p=10ms, T_{vj}=125^{\circ}C$	810	A <sup>2</sup> S
		$V_R=0, t_p=10ms, T_{vj}=150^{\circ}C$	690	

### Electrical Characteristics

Parameter	Symbol	Test Conditions	Min	Typ	Max	Unit
Forward Voltage	$V_F$	$I_F=75A, T_{vj}=25^{\circ}C$		1.95	2.60	V
		$I_F=75A, T_{vj}=125^{\circ}C$		1.78		V
		$I_F=75A, T_{vj}=150^{\circ}C$		1.70		V
Recovered Charge	$Q_{rr}$	$I_F=75A, V_R=600V,$ $-diF/dt=1700A/\mu s,$ $T_{vj}=25^{\circ}C$		2.1		$\mu C$
Peak Reverse Recovery Current	$I_{rr}$			53		A
Reverse Recovery Energy	$E_{rec}$			0.35		mJ
Recovered Charge	$Q_{rr}$	$I_F=75A, V_R=600V,$ $-diF/dt=1700A/\mu s,$ $T_{vj}=150^{\circ}C$		5.8		$\mu C$
Peak Reverse Recovery Current	$I_{rr}$			56		A
Reverse Recovery Energy	$E_{rec}$			1.67		mJ

● IGBT- Brake-chopper

Maximum Ratings

Parameter	Symbol	Test Conditions	Rating	Unit
Collector-Emitter Voltage	$V_{CES}$	$V_{GE}=0V, I_C=1mA, T_{vj}=25^{\circ}C$	1200	V
Continuous Collector Current	$I_C$	$T_C=100^{\circ}C, T_{vjmax}=175^{\circ}C$	50	A
Repetitive Peak Collector Current	$I_{CRM}$	$t_p=1ms$	100	A
Gate-Emitter Voltage	$V_{GES}$	$T_{vj}=25^{\circ}C$	$\pm 20$	V
Total Power Dissipation	$P_{tot}$	$T_C=25^{\circ}C, T_{vjmax}=175^{\circ}C$	442	W

Electrical Characteristics

Parameter	Symbol	Test Conditions	Min	Typ	Max	Unit
Gate-Emitter Threshold Voltage	$V_{GE(th)}$	$V_{GE}=V_{CE}, I_C=1.7mA, T_{vj}=25^{\circ}C$	5.0	5.7	6.5	V
Collector-Emitter Cut-off Current	$I_{CES}$	$V_{CE}=1200V, V_{GE}=0V, T_{vj}=25^{\circ}C$			1.0	mA
Collector-Emitter Saturation Voltage	$V_{CE(sat)}$	$I_C=50A, V_{GE}=15V, T_{vj}=25^{\circ}C$		1.90		V
		$I_C=50A, V_{GE}=15V, T_{vj}=125^{\circ}C$		2.25		V
		$I_C=50A, V_{GE}=15V, T_{vj}=150^{\circ}C$		2.32		V
Gate Charge	$Q_g$			0.35		$\mu C$
Input Capacitance	$C_{ies}$	$V_{CE}=25V, V_{GE}=0V, f=1MHz, T_{vj}=25^{\circ}C$		2.60		nF
Reverse Transfer Capacitance	$C_{res}$			0.10		
Gate-Emitter leakage current	$I_{GES}$	$V_{CE}=0V, V_{GE}=20V, T_{vj}=25^{\circ}C$			400	nA
Turn-On Delay Time	$t_{d(on)}$	$V_{CE}=600V, I_C=50A, V_{GE}=\pm 15V, R_G=20\Omega, T_{vj}=25^{\circ}C$		41		ns
Rise Time	$t_r$			48		
Turn-Off Delay Time	$t_{d(off)}$			160		
Fall Time	$t_f$			244		
Turn-On Energy	$E_{on}$	$V_{CE}=600V, I_C=50A, V_{GE}=\pm 15V, R_G=20\Omega, T_{vj}=150^{\circ}C$		5.92		mJ
Turn-Off Energy	$E_{off}$			3.39		
Turn-On Delay Time	$t_{d(on)}$			45		
Rise Time	$t_r$			50		
Turn-Off Delay Time	$t_{d(off)}$	$V_{CE}=600V, I_C=50A, V_{GE}=\pm 15V, R_G=20\Omega, T_{vj}=150^{\circ}C$		169		ns
Fall Time	$t_f$			302		
Turn-On Energy	$E_{on}$			6.87		
Turn-Off Energy	$E_{off}$			3.73		
SC Data	$I_{SC}$	$T_p \leq 10\mu s, V_{GE}=15V, T_{vj}=150^{\circ}C, V_{CC}=900V, V_{CEM} \leq 1200V$		200		A

## ● Diode- Brake-chopper

### Maximum Ratings

Parameter	Symbol	Test Conditions	Rating	Unit
Repetitive Peak Reverse Voltage	$V_{RRM}$	$T_{vj}=25^{\circ}C$	1200	V
Continuous DC Forward Current	$I_F$		35	A
Repetitive Peak Forward Current	$I_{FRM}$	$t_p=1ms$	70	A
$I^2t$ -value	$I^2t$	$V_R=0, t_p=10ms, T_{vj}=125^{\circ}C$	240	$A^2s$
		$V_R=0, t_p=10ms, T_{vj}=150^{\circ}C$	220	

### Electrical Characteristics

Parameter	Symbol	Test Conditions	Min	Typ	Max	Unit
Forward Voltage	$V_F$	$I_F=35A, T_{vj}=25^{\circ}C$		1.95		V
		$I_F=35A, T_{vj}=125^{\circ}C$		1.78		V
		$I_F=35A, T_{vj}=150^{\circ}C$		1.69		V
Recovered Charge	$Q_{rr}$	$I_F=35A, V_R=600V,$ $-di_F/dt=1600A/\mu s, T_{vj}=25^{\circ}C$		2.35		$\mu C$
Peak Reverse Recovery Current	$I_{rr}$			21		A
Reverse Recovery Energy	$E_{rec}$			0.67		mJ
Recovered Charge	$Q_{rr}$	$I_F=35A, V_R=600V,$ $-di_F/dt=1600A/\mu s, T_{vj}=150^{\circ}C$		3.81		$\mu C$
Peak Reverse Recovery Current	$I_{rr}$			25		A
Reverse Recovery Energy	$E_{rec}$			1.13		mJ

## ● Diode- Rectifier

### Maximum Ratings

Parameter	Symbol	Test Conditions	Rating	Unit
Repetitive Peak Reverse Voltage	$V_{RRM}$	$T_j=25^{\circ}C$	1600	V
Average On-state Current 50/60Hz, sine wave	$I_{F(AV)}$	$T_C=100^{\circ}C$	80	A
Maximum RMS Current at Rectifier Output	$I_{RMSM}$	$T_C=100^{\circ}C$	120	A
Surge Forward Current	$I_{FSM}$	$V_R=0, t_p=10ms, T_j=25^{\circ}C$	1200	A
		$V_R=0, t_p=10ms, T_j=150^{\circ}C$	1000	A
$I^2t$ -value	$I^2t$	$V_R=0, t_p=10ms, T_j=25^{\circ}C$	7200	$A^2s$
		$V_R=0, t_p=10ms, T_j=150^{\circ}C$	5000	$A^2s$

### Electrical Characteristics

Parameter	Symbol	Test Conditions	Min	Typ	Max	Unit
Diode Forward Voltage	$V_F$	$I_F=50A, T_j=125^{\circ}C$		0.98		V
Reverse Current	$I_r$	$T_j=125^{\circ}C, V_R=1600V$			2.0	mA

## ● NTC-Thermistor

### Electrical Characteristics

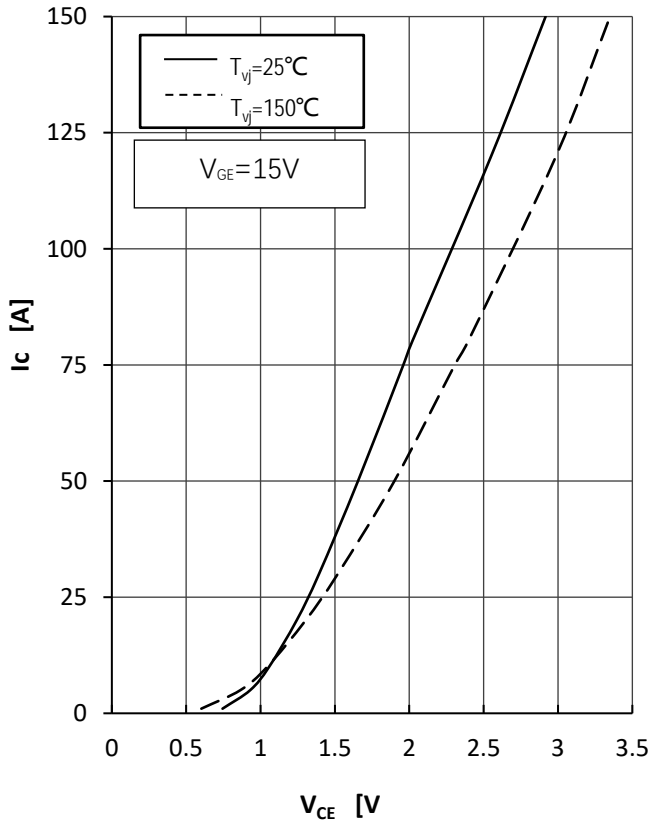
Parameter	Symbol	Test Conditions	Min	Typ	Max	Unit
Rated Resistance	$R_{25}$			5		k $\Omega$
Deviation of R100	$\Delta R/R$	$T_C=100, R_{100}=493.3\Omega$	-5		5	%
Power Dissipation	$P_{25}$				20	mW
B-value	$B_{25/50}$	$R_2=R_{25}\exp[B_{25/50}(1/T_2-1/(298.15K))]$		3375		K

**● Module Characteristics( $T_C=25^{\circ}\text{C}$  unless otherwise specified)**

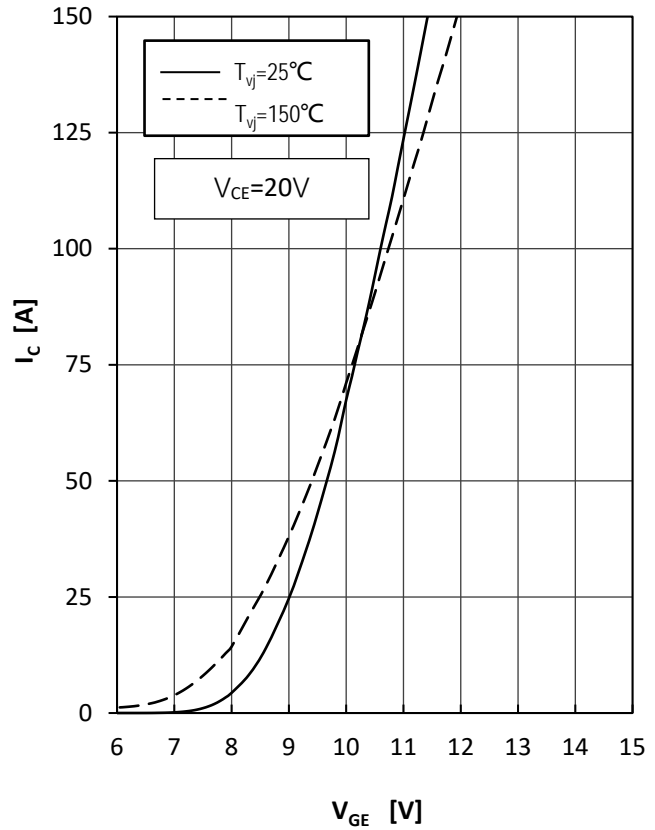
Parameter	Symbol	Test Conditions	Min	Typ	Max	Unit
Isolation voltage	$V_{\text{isol}}$	$t=1\text{min}, f=50\text{Hz}$	2500			V
Maximum Junction Temperature	$T_{\text{Jmax}}$				175	$^{\circ}\text{C}$
Operating Junction Temperature	$T_{\text{vj op}}$		-40		150	$^{\circ}\text{C}$
Storage Temperature	$T_{\text{stg}}$		-40		125	$^{\circ}\text{C}$
Stray inductance module	$L_{\text{SCE}}$			60		nH
Module Lead Resistance , Terminal to Chip	$R_{\text{CC'+EE'}}$	$T_C=25^{\circ}\text{C}$ , per switch		4.0		m $\Omega$
	$R_{\text{AA'+CC'}}$			3.0		
Thermal Resistance Junction to Case	$R_{\theta\text{jc}}$	per IGBT-inverter		0.315		K/W
		per Diode-inverter		0.619		
		per IGBT-brake-chopper		0.500		
		per Diode-chopper		1.266		
		per Diode-rectifier		0.635		
Thermal Resistance Case to Sink	$R_{\theta\text{cs}}$	per IGBT-inverter		0.121		K/W
		per Diode-inverter		0.221		
		per IGBT-brake-chopper		0.180		
		per Diode-chopper		0.452		
		per Diode-rectifier		0.227		
		per Module		0.009		
Mounting Force Per Clamp	F		3.0		6.0	N
Weight of Module	G			300		g

**Curve Characteristics**

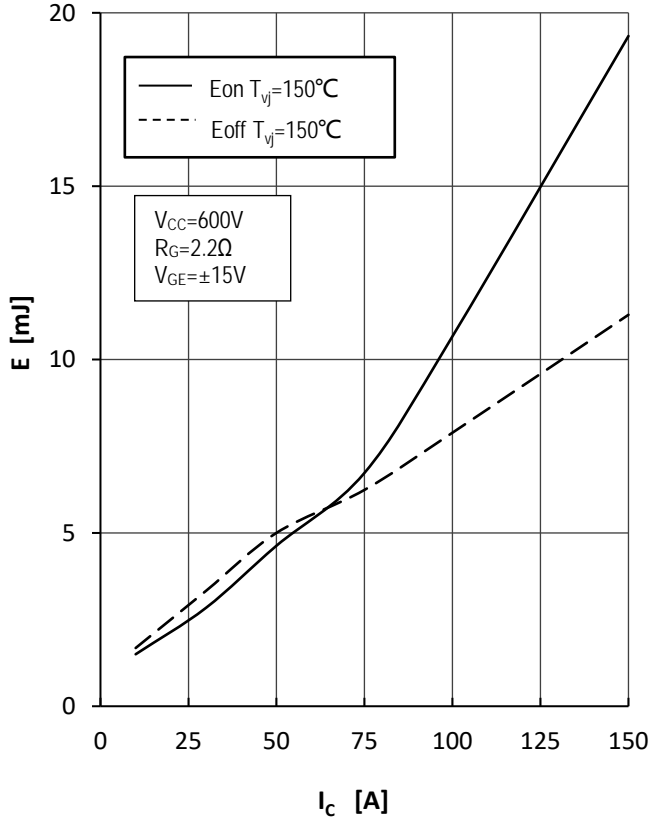
**Fig1.IGBT Output Characteristics**



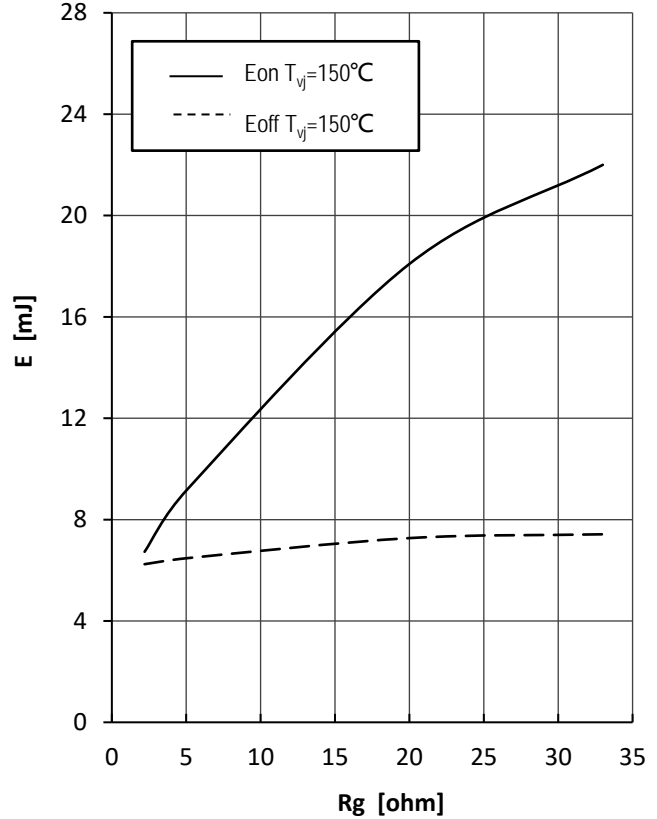
**Fig2.IGBT Transfer Characteristics**



**Fig3.IGBT Switching Loss vs.Ic**



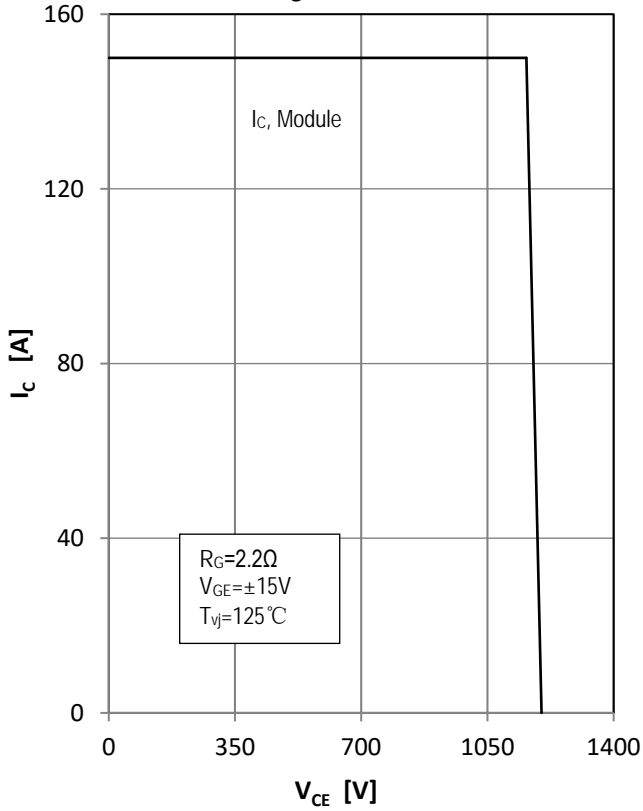
**Fig4.IGBT Switching Loss vs.Rg**



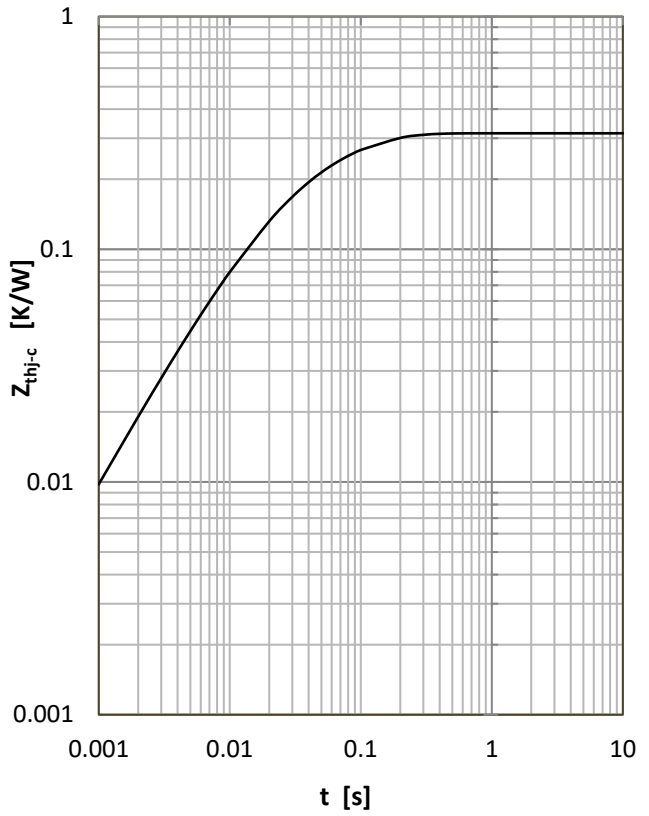


**Curve Characteristics**

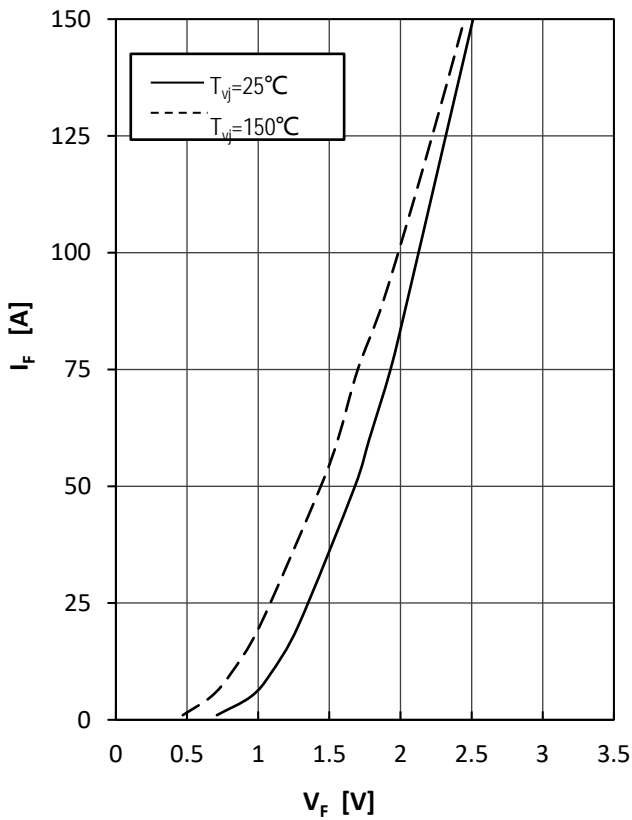
**Fig5. RBSOA**



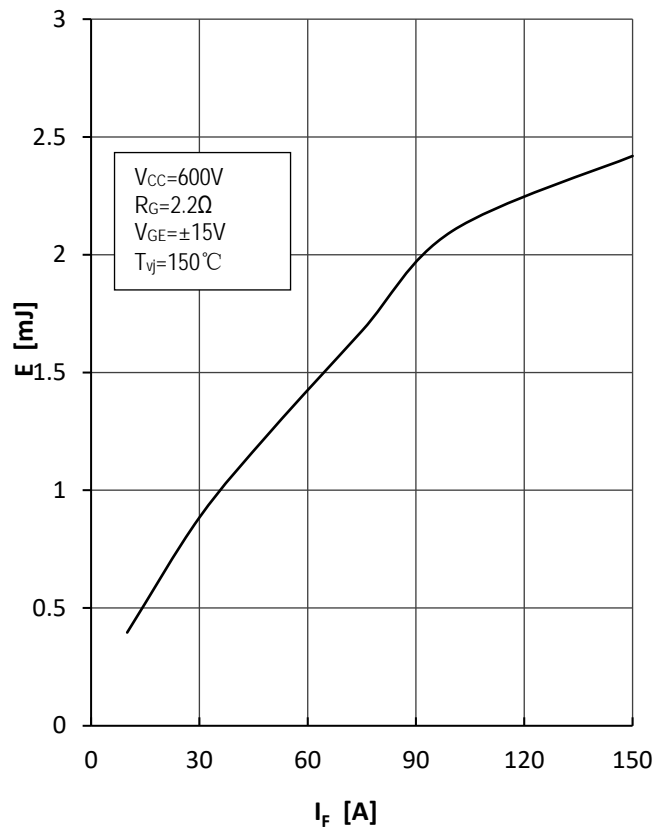
**Fig 6. IGBT Transient Thermal Impedance**



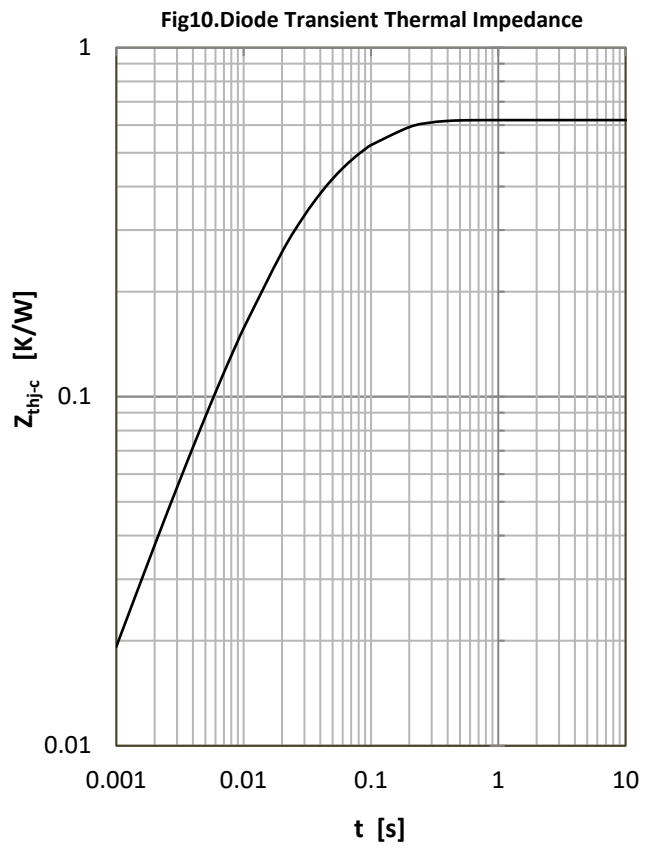
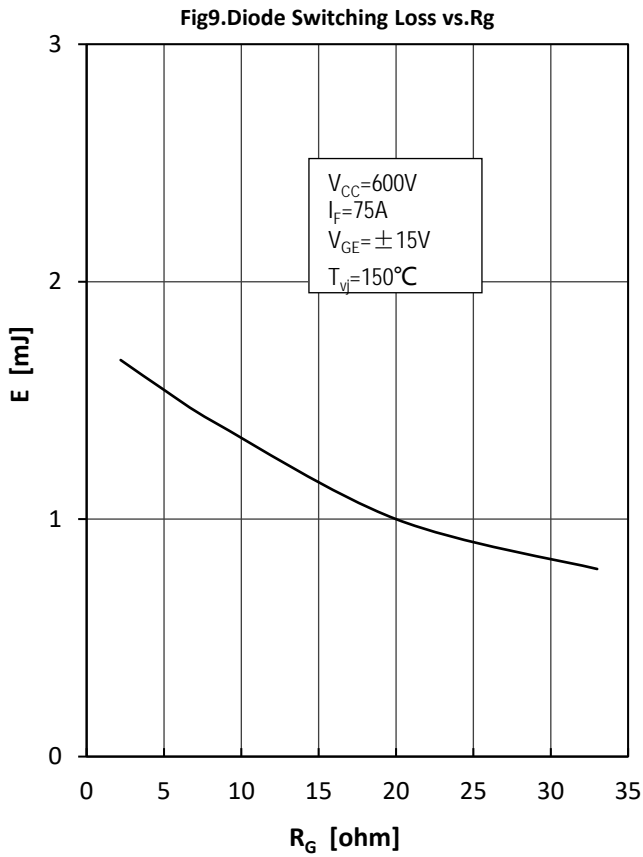
**Fig7. Diode Foward Characteristics**



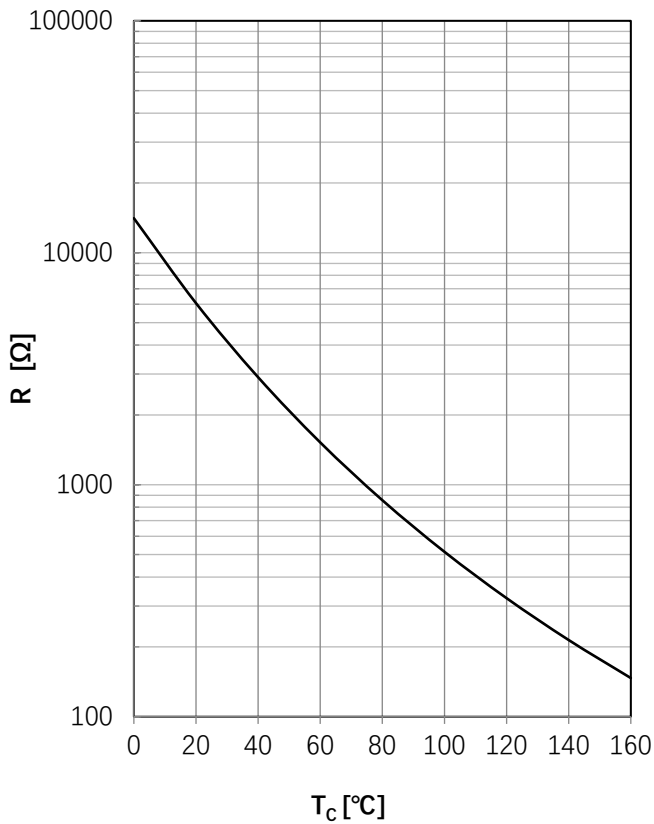
**Fig8. Diode Switching Loss vs. If**



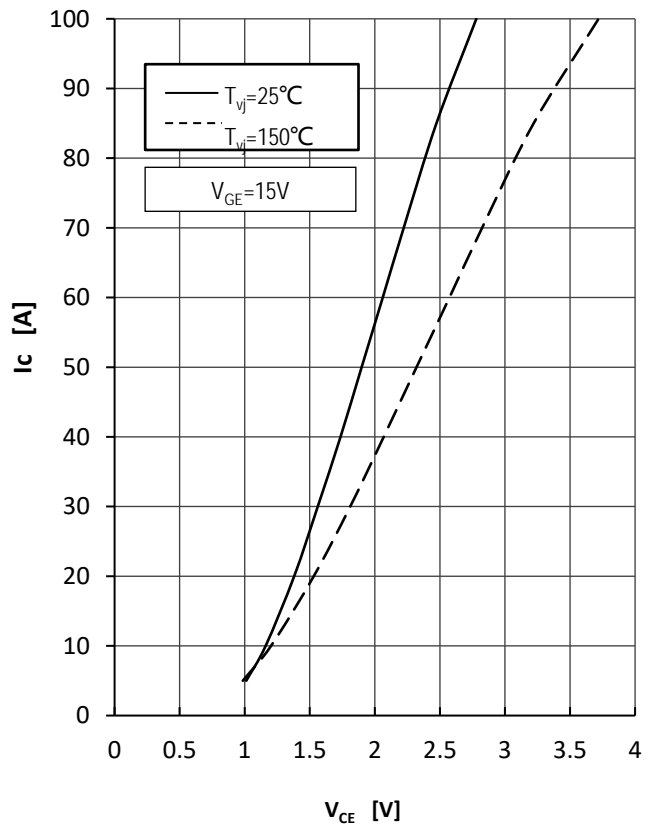
**Curve Characteristics**



**Fig 11. NTC Temperature Characteristic**

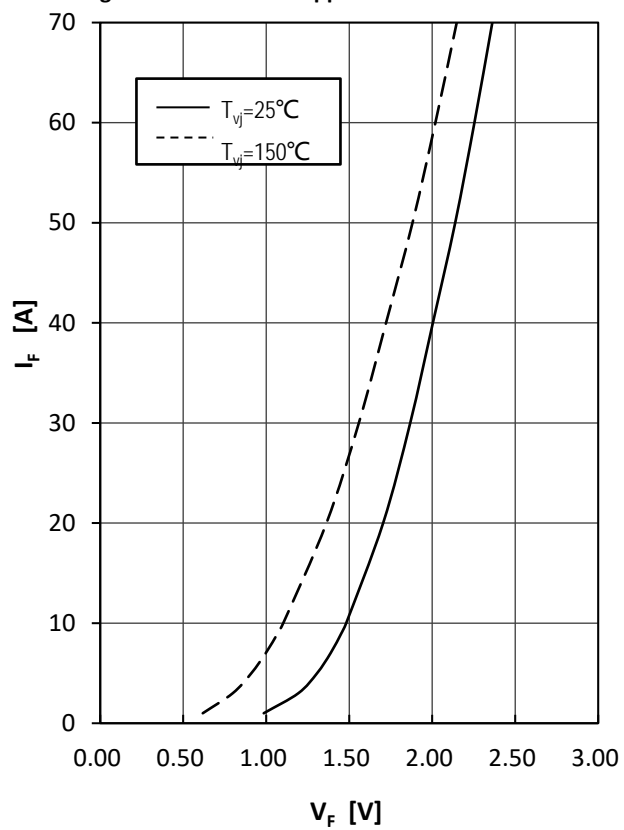


**Fig12. IGBT-brake-Chopper output Characteristics**

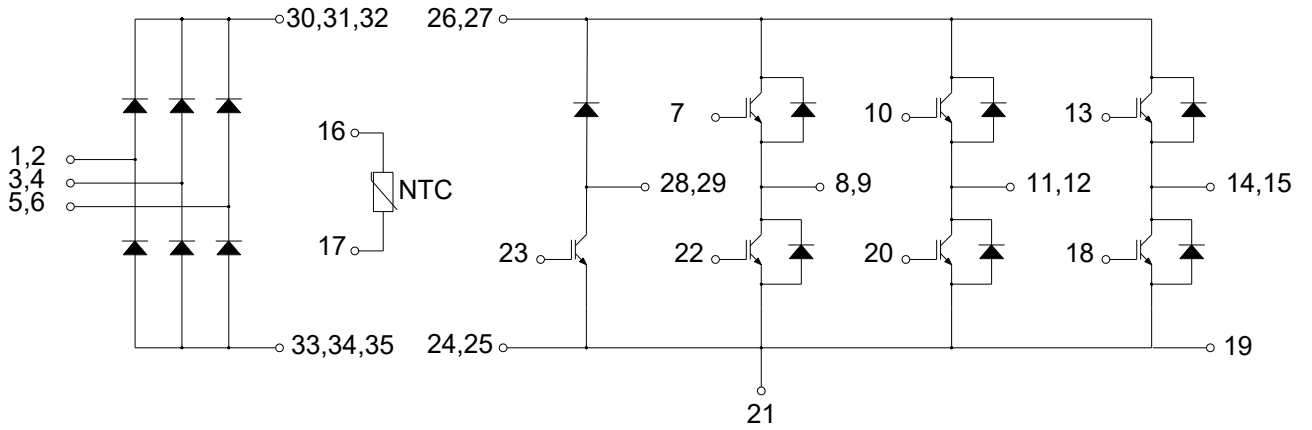


## Curve Characteristics

Fig13. Diode-brake-chopper Forward Characteristics



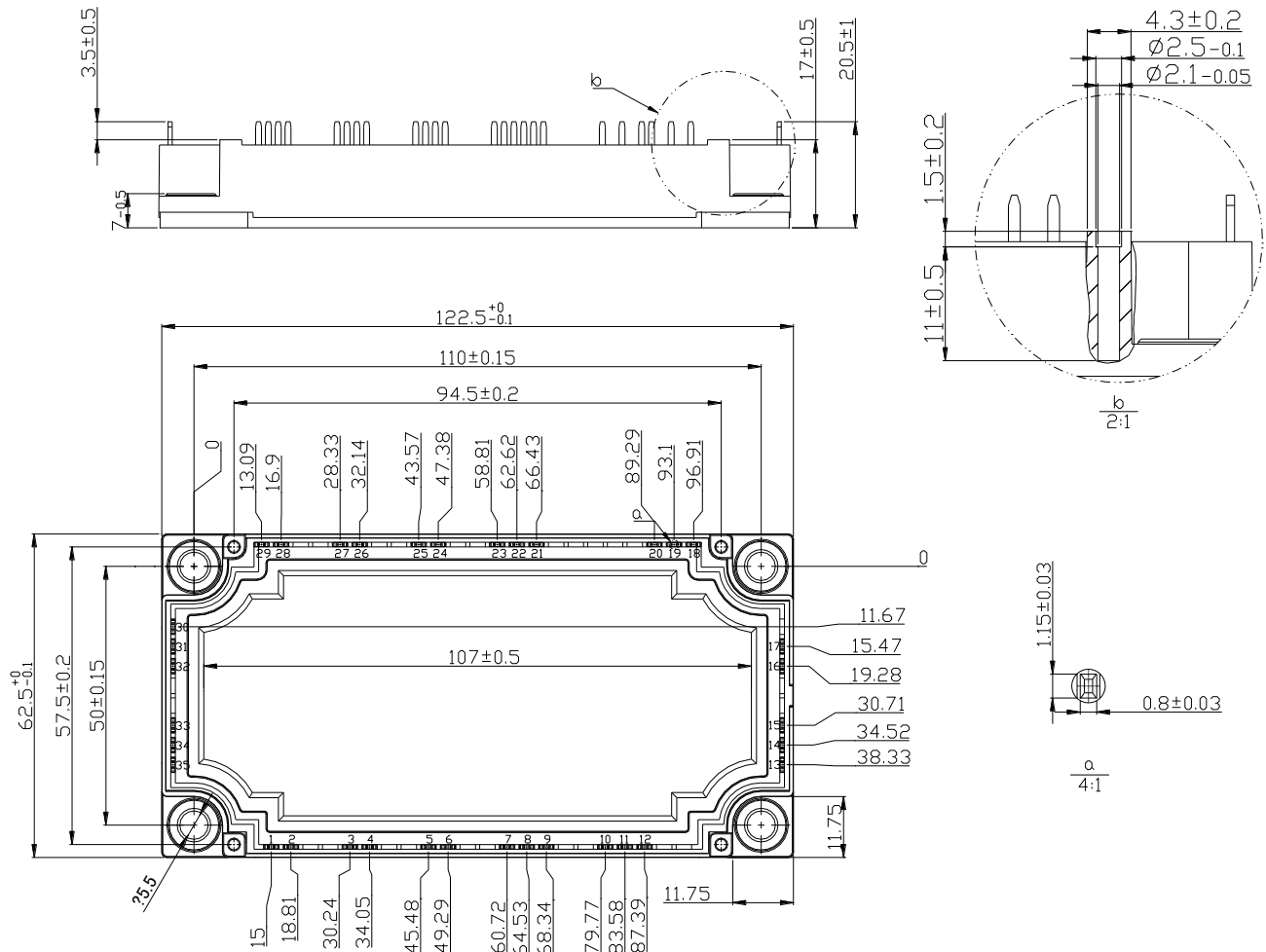
### Circuit Diagram



### Package Dimensions

Dimensions in mm

**E2**



## Ordering Information

Device	Packing
Part Number-BP	Bulk: 6pcs/Box ; 36pcs/Ctn

**\*\*\*IMPORTANT NOTICE\*\*\***

*Micro Commercial Components Corp.* reserves the right to make changes without further notice to any product herein to make corrections, modifications , enhancements , improvements , or other changes . *Micro Commercial Components Corp.* does not assume any liability arising out of the application or use of any product described herein; neither does it convey any license under its patent rights ,nor the rights of others . The user of products in such applications shall assume all risks of such use and will agree to hold *Micro Commercial Components Corp.* and all the companies whose products are represented on our website, harmless against all damages. *Micro Commercial Components Corp.* products are sold subject to the general terms and conditions of commercial sale, as published at <https://www.mccsemi.com/Home/TermsAndConditions>.

**\*\*\*LIFE SUPPORT\*\*\***

MCC's products are not authorized for use as critical components in life support devices or systems without the express written approval of Micro Commercial Components Corporation.

**\*\*\*CUSTOMER AWARENESS\*\*\***

Counterfeiting of semiconductor parts is a growing problem in the industry. Micro Commercial Components (MCC) is taking strong measures to protect ourselves and our customers from the proliferation of counterfeit parts. MCC strongly encourages customers to purchase MCC parts either directly from MCC or from Authorized MCC Distributors who are listed by country on our web page cited below. Products customers buy either from MCC directly or from Authorized MCC Distributors are genuine parts, have full traceability, meet MCC's quality standards for handling and storage. **MCC will not provide any warranty coverage or other assistance for parts bought from Unauthorized Sources.** MCC is committed to combat this global problem and encourage our customers to do their part in stopping this practice by buying direct or from authorized distributors.