

	E502650
---	----------------

Features

- Low $V_{CE(sat)}$ With Trench Technology
- $V_{CE(sat)}$ With Positive Temperature Coefficient
- High Short Circuit Capability(10us)
- Including Ultra Fast & Soft Recovery Anti-parallel FWD
- Low Inductance
- Maximum Junction Temperature 175°C
- Epoxy Meets UL 94 V-0 Flammability Rating
- Lead Free Finish/RoHS Compliant (Note 1)("P" Suffix Designates RoHS Compliant. See Ordering Information)

Applications

- Inverter for Motor Drive
- AC and DC Servo Driver Amplifier
- UPS(Uninterruptible Power Supplies)
- Soft Switching Welding Machine

Parameter	Symbol	Rating	Unit	
Collector-Emitter Voltage@ $V_{GE}=0V, I_C=1mA, T_{vj}=25^{\circ}C$	V_{CES}	1200	V	
Continuous Collector Current @ $T_C=100^{\circ}C$	I_C	75	A	
Repetitive Peak Collector Current @ $t_p=1ms$	I_{CRM}	150	A	
Gate-Emitter Voltage@ $T_{vj}=25^{\circ}C$	V_{GES}	± 20	V	
Isolation Voltage @ $f=50Hz, t=1min$	V_{isol}	2500(Min)	V	
Weight of Module	G	150	g	
Module Electrodes Torque:M5	M_t	2.5~5	N*m	
Module-to-Sink Torque :M6	M_s	3~5	N*m	
Total Power Dissipation (IGBT-Inverter)	$T_C=25^{\circ}C$	P_{tot}	530	W
	$T_{vjmax}=175^{\circ}C$			

Note:

1. High Temperature Solder Exemptions Applied, see EU Directive Annex 7a.

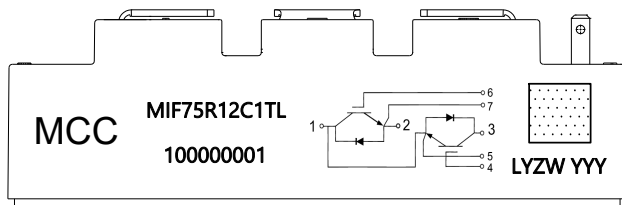

Marking Code Contents:

Logo: MCC

Product Number:MIF75R12C1TL

Trace Code: 10 Digits

Circuit Diagram

2D Code format: Data Matrix

IGBT Modules 1200V 75A

C1

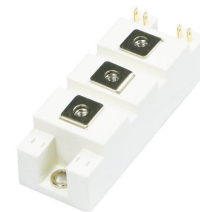
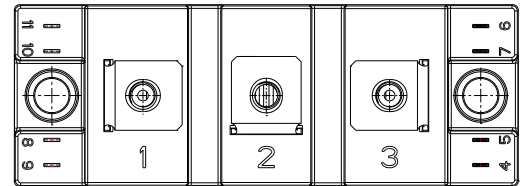
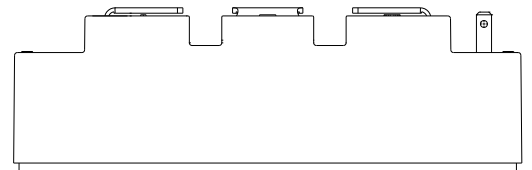

Circuit Diagram

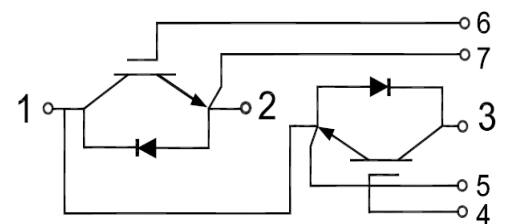

Electrical Characteristics of IGBT @ 25°C (Unless Otherwise Specified)

Parameter	Symbol	Test Conditions	Min	Typ	Max	Unit
Gate-emitter Threshold Voltage	$V_{GE(th)}$	$I_C=3mA, V_{CE}=V_{GE}, T_{vj}=25^\circ C$	5.0	6.2	7.0	V
Collector-Emitter Cut-off Current	I_{CES}	$V_{CE}=1200V, V_{GE}=0V, T_{vj}=25^\circ C$			1.0	mA
Collector-Emitter Saturation Voltage	$V_{CE(sat)}$	$I_c=75A, V_{GE}=15V, T_{vj}=25^\circ C$		1.85		V
		$I_c=75A, V_{GE}=15V, T_{vj}=125^\circ C$		2.05		
Input Capacitance	C_{ies}	$V_{CE}=25V, V_{GE}=0V, f=1MHz, T_{vj}=25^\circ C$		5.52		nF
Reverse Transfer Capacitance	C_{res}			0.26		
Gate-Emitter leakage current	I_{GES}	$V_{CE}=0V, V_{GE}=20V, T_{vj}=25^\circ C$			400	nA
Turn-On Delay Time	$td_{(on)}$	$V_{CE}=600V, I_C=75A, V_{GE}=\pm 15V, R_G=10\Omega, T_J=25^\circ C$		305		ns
Rise Time	t_r			67		
Turn-Off Delay Time	$td_{(off)}$			328		
Fall Time	t_f			187		mJ
Turn-On Energy	E_{on}			6.7		
Turn-Off Energy	E_{off}			4.3		
Turn-On Delay Time	$td_{(on)}$	$V_{CE}=600V, I_C=75A, V_{GE}=\pm 15V, R_G=10\Omega, T_J=125^\circ C$		311		ns
Rise Time	t_r			70		
Turn-Off Delay Time	$td_{(off)}$			347		
Fall Time	t_f			337		mJ
Turn-On Energy	E_{on}			9.7		
Turn-Off Energy	E_{off}			7		
SC Data	I_{sc}	$t_p \leq 10\mu s, V_{GE}=15V, T_{vj}=150^\circ C, V_{cc}=600V, V_{CEM} \leq 1200V$		420		A

Electrical Characteristics of DIODE @ 25°C (Unless Otherwise Specified)

Parameter	Symbol	Test Conditions	Value	Unit
Repetitive Peak Reverse Voltage	V_{RRM}	$T_{vj}=25^{\circ}C$	1200	V
Continuous DC Forward Current	I_F		75	A
Repetitive Peak Forward Current	I_{FRM}	$t_p=1ms$	150	A

Parameter	Symbol	Test Conditions	Min	Typ	Max	Unit
Forward Voltage	V_F	$I_F=75A, T_{vj}=25^{\circ}C$		1.87		V
		$I_F=75A, T_{vj}=125^{\circ}C$		1.7		
Recovered Charge	Q_{rr}	$I_F=75A$ $V_R=600V$		4.8		μC
Peak Reverse Recovery Current	I_{rr}	$-diF/dt = 1200A/us$		60		A
Reverse Recovery Energy	E_{rec}	$T_{vj}=25^{\circ}C$		3.8		mJ
Recovered Charge	Q_{rr}	$I_F=75A$ $V_R=600V$		10.2		μC
Peak Reverse Recovery Current	I_{rr}	$-diF/dt = 1200A/us$		77		A
Reverse Recovery Energy	E_{rec}	$T_{vj}=125^{\circ}C$		5.7		mJ

Module Characteristics

Parameter	Symbol	Test Conditions	Min	Typ	Max	Unit
Isolation voltage	V_{isol}	$t=1min, f=50Hz$	2500			V
Maximum Junction Temperature	T_{jmax}				175	$^{\circ}C$
Operating Junction Temperature	$T_{vj op}$		-40		150	$^{\circ}C$
Storage Temperature	T_{stg}		-40		125	$^{\circ}C$
Thermal Resistance Junction to Case	$R_{\theta JC}$	per IGBT			0.26	K/W
		per Diode			0.42	
Thermal Resistance Case-to Sink	$R_{\theta CS}$	Conductive grease applied		0.05		K/W

Curve Characteristics

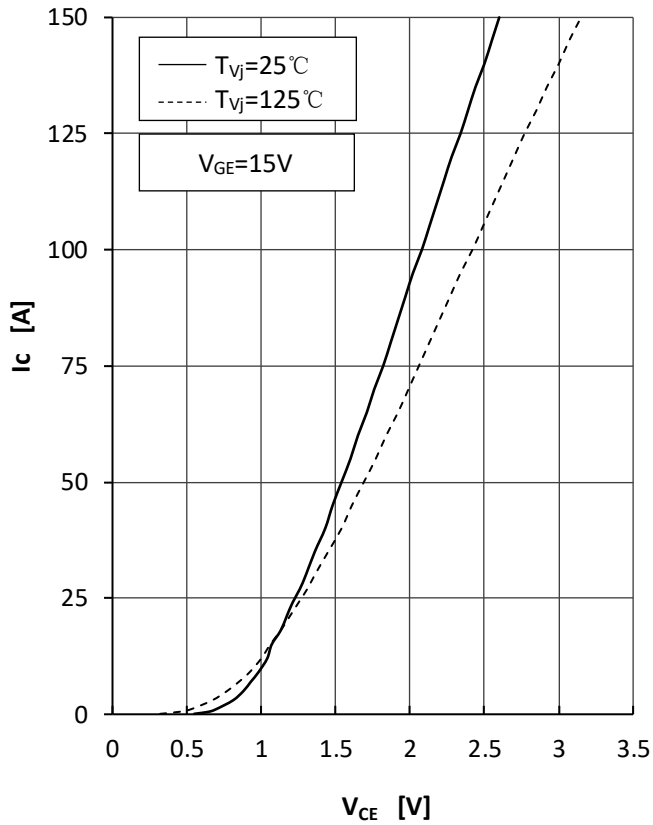

Fig1.IGBT Output Characteristics

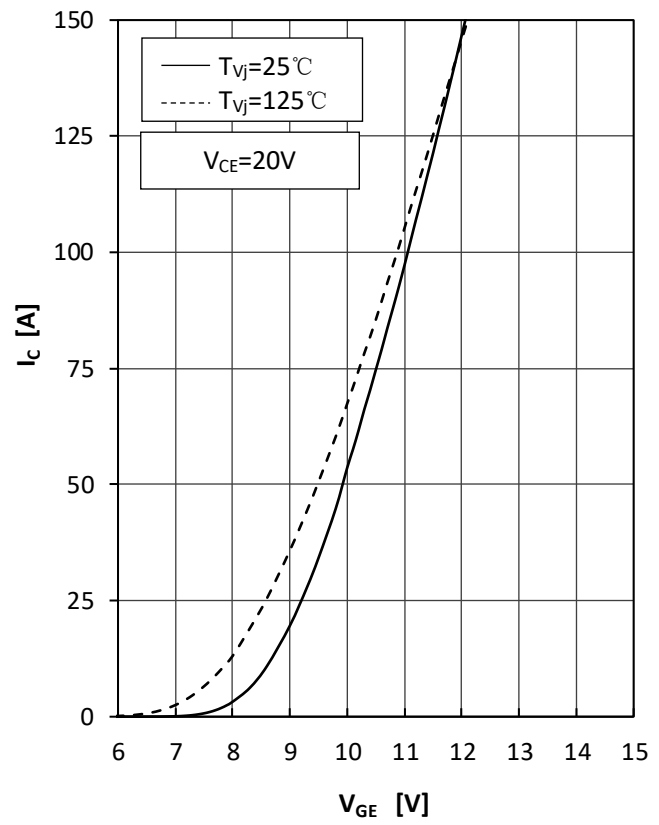

Fig2.IGBT Transfer Characteristics

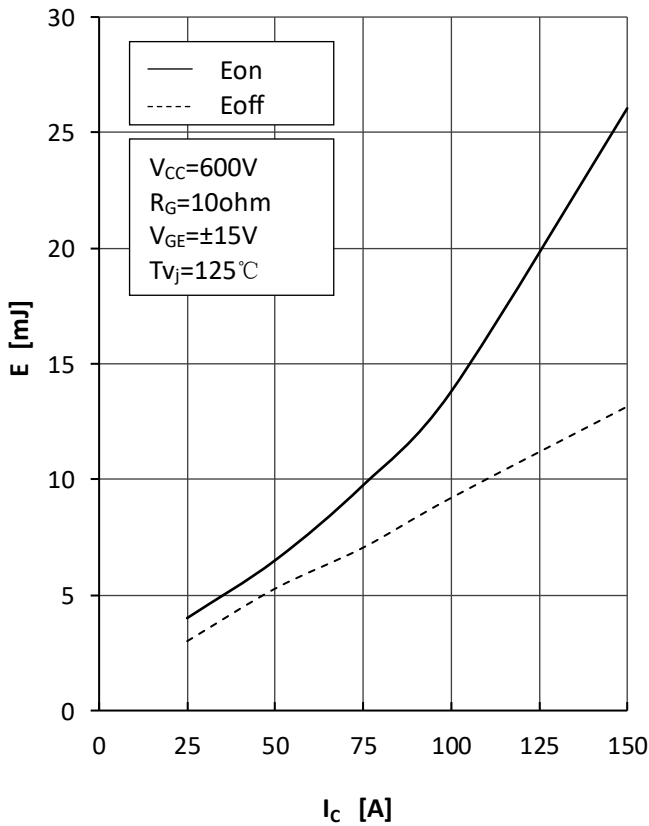

Fig3.IGBT Switching Loss vs.Ic

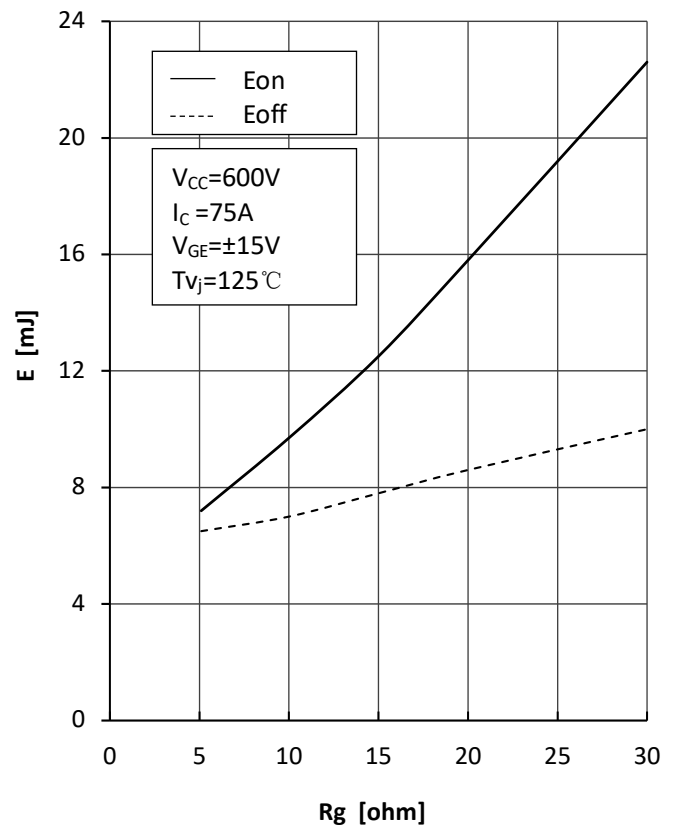
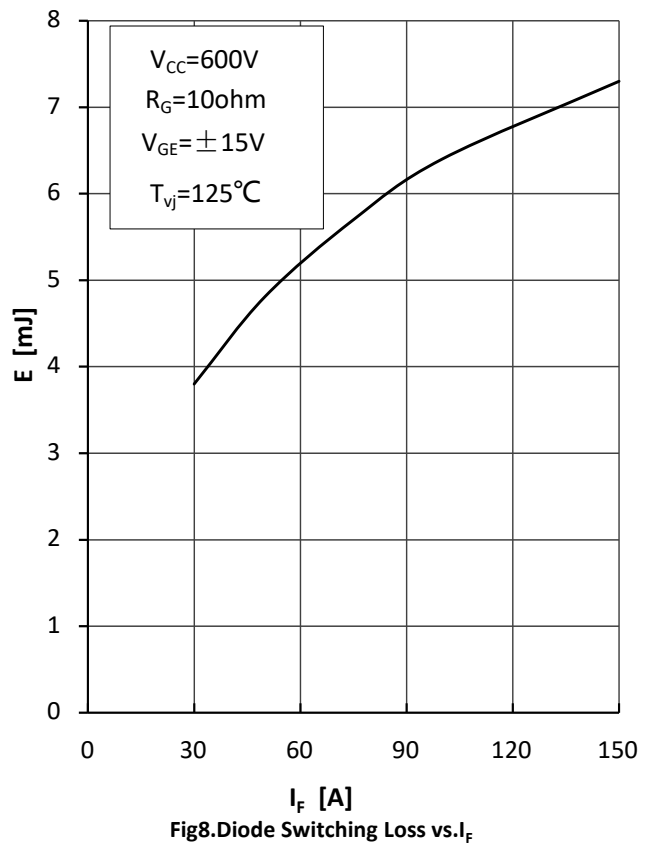
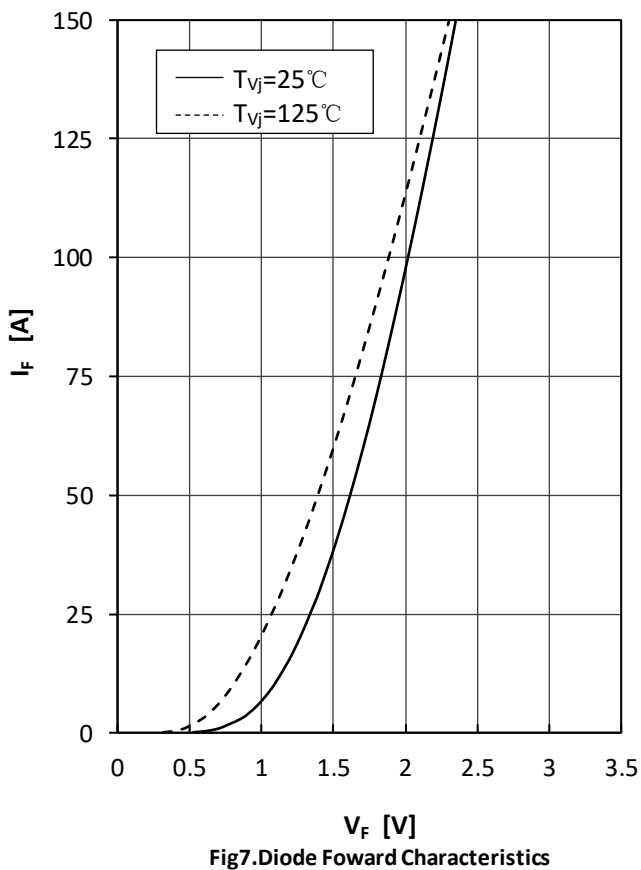
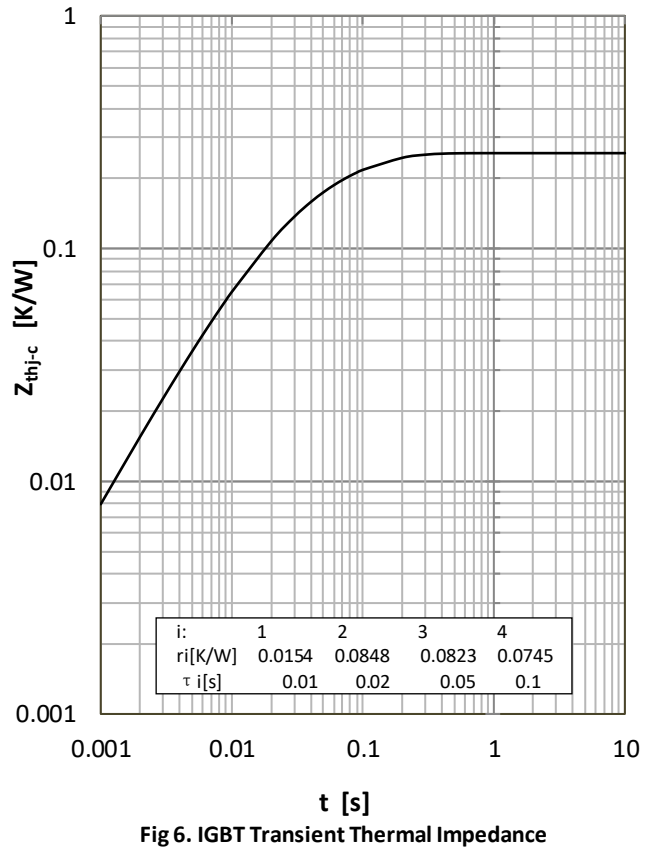
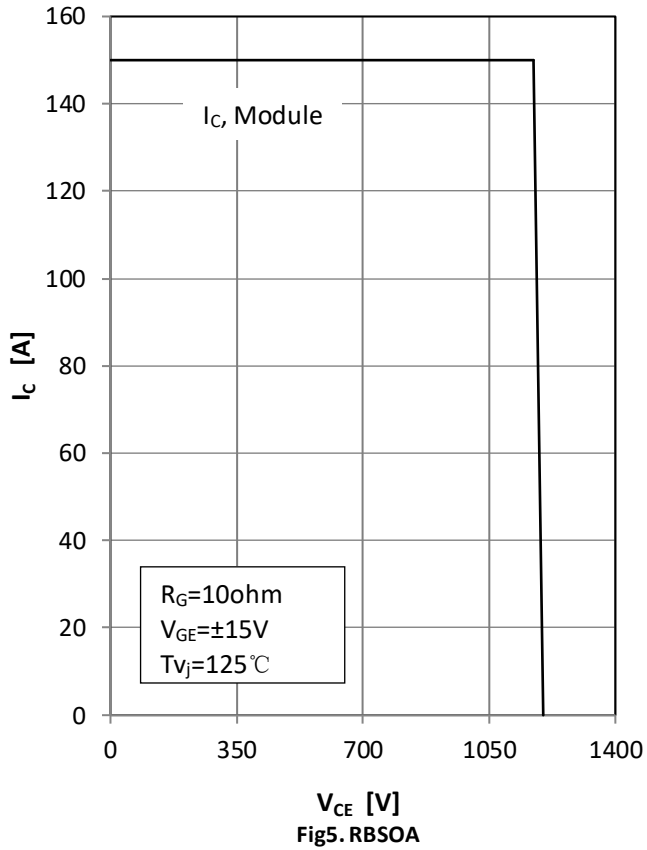

Fig4.IGBT Switching Loss vs.Rg

Curve Characteristics



Curve Characteristics

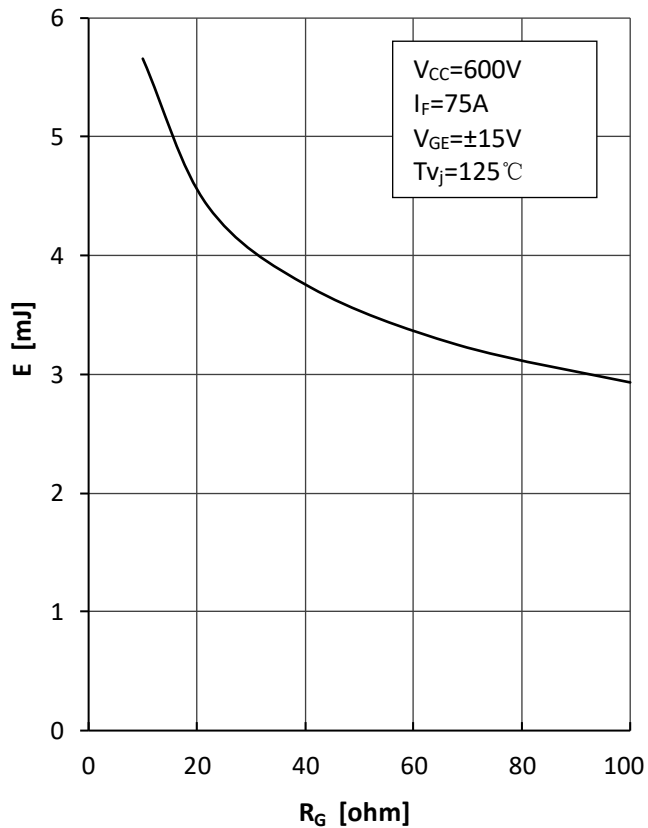

Fig9.Diode Switching Loss vs.Rg

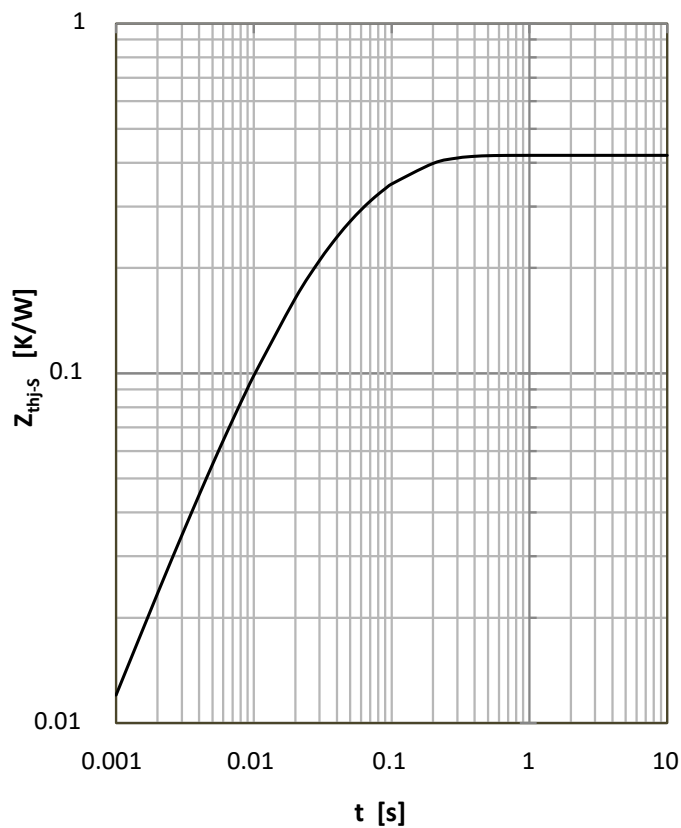
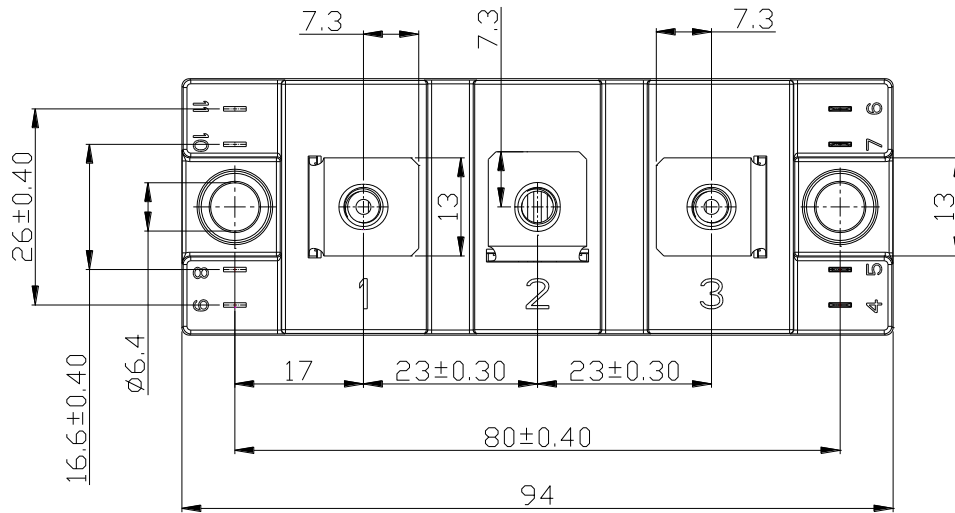
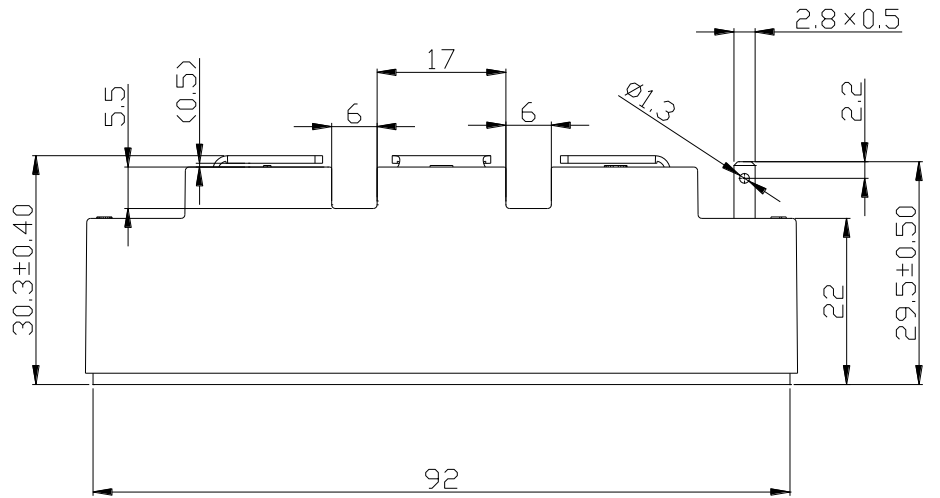

Fig10.Diode Transient Thermal Impedance

Package Dimensions

C1

Dimensions in mm



Ordering Information

Device	Packing
Part Number-BP	Bulk: 10pcs/Box ; 50pcs/Ctn

*****IMPORTANT NOTICE*****

Micro Commercial Components Corp. reserves the right to make changes without further notice to any product herein to make corrections, modifications , enhancements , improvements , or other changes . **Micro Commercial Components Corp .** does not assume any liability arising out of the application or use of any product described herein; neither does it convey any license under its patent rights ,nor the rights of others . The user of products in such applications shall assume all risks of such use and will agree to hold **Micro Commercial Components Corp .** and all the companies whose products are represented on our website, harmless against all damages. **Micro Commercial Components Corp.** products are sold subject to the general terms and conditions of commercial sale, as published at <https://www.mccsemi.com/Home/TermsAndConditions>.

*****LIFE SUPPORT*****

MCC's products are not authorized for use as critical components in life support devices or systems without the express written approval of Micro Commercial Components Corporation.

*****CUSTOMER AWARENESS*****

Counterfeiting of semiconductor parts is a growing problem in the industry. Micro Commercial Components (MCC) is taking strong measures to protect ourselves and our customers from the proliferation of counterfeit parts. MCC strongly encourages customers to purchase MCC parts either directly from MCC or from Authorized MCC Distributors who are listed by country on our web page cited below. Products customers buy either from MCC directly or from Authorized MCC Distributors are genuine parts, have full traceability, meet MCC's quality standards for handling and storage. **MCC will not provide any warranty coverage or other assistance for parts bought from Unauthorized Sources.** MCC is committed to combat this global problem and encourage our customers to do their part in stopping this practice by buying direct or from authorized distributors.